

## CABINETS AND FRAMES

Cabinets and frames of the FX fire detection system

### Battery cabinet FXM-BAT

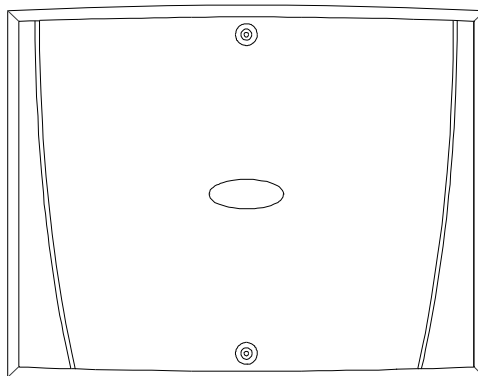
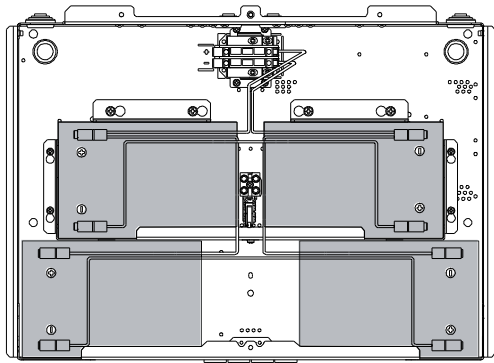

### Mounting cabinet FXM-CAB

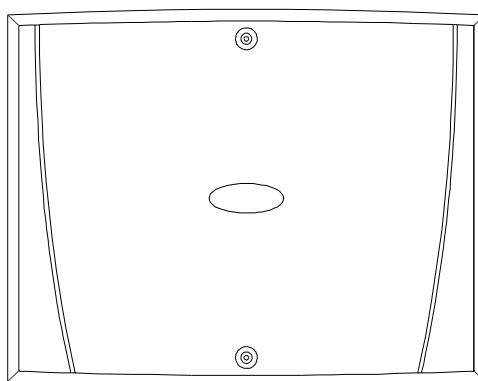
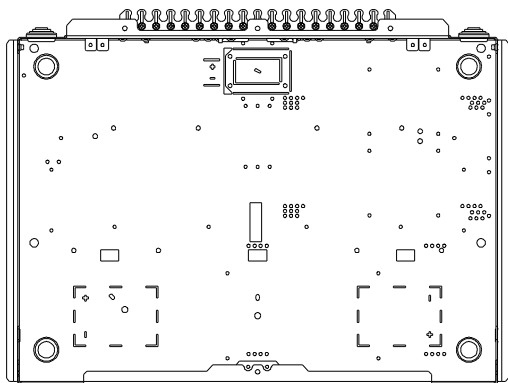

### Battery cabinet AX/FX/IX-BAT

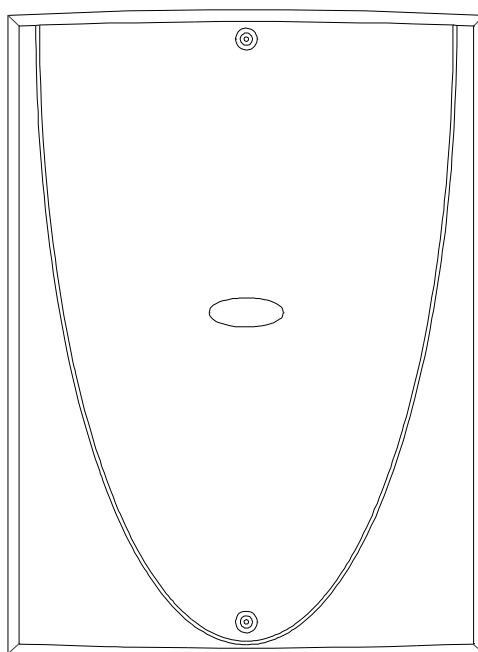
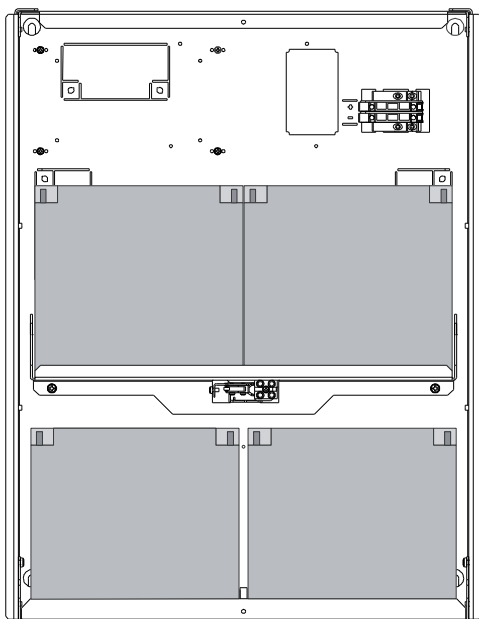

**Mounting cabinet FX-CAB**

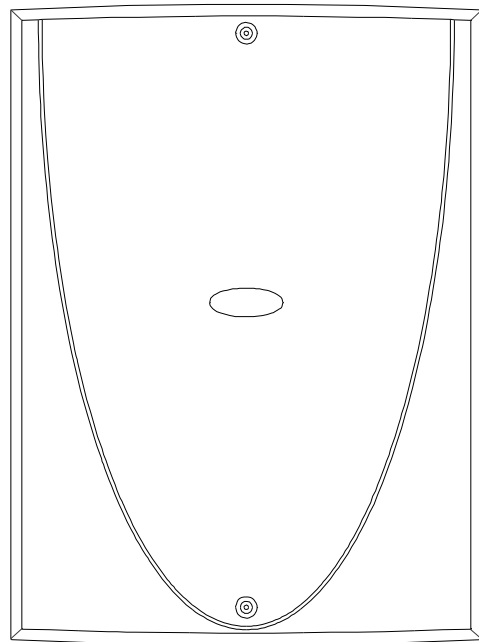
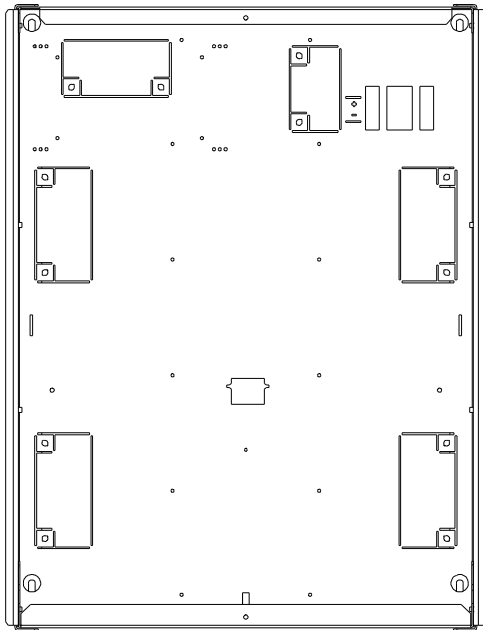

**Recess mounting frame FXM-RMFW**

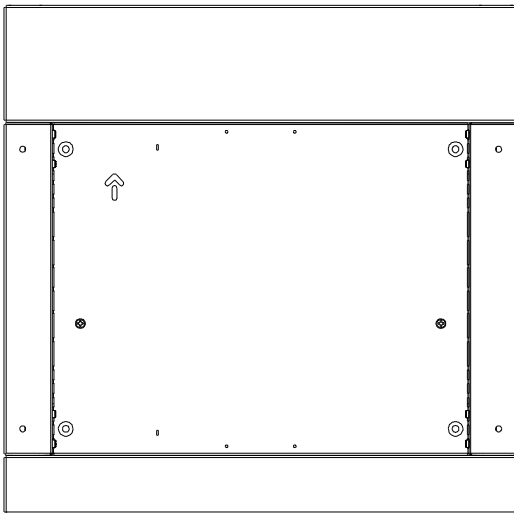

**Recess mounting frame FX-RMFW**

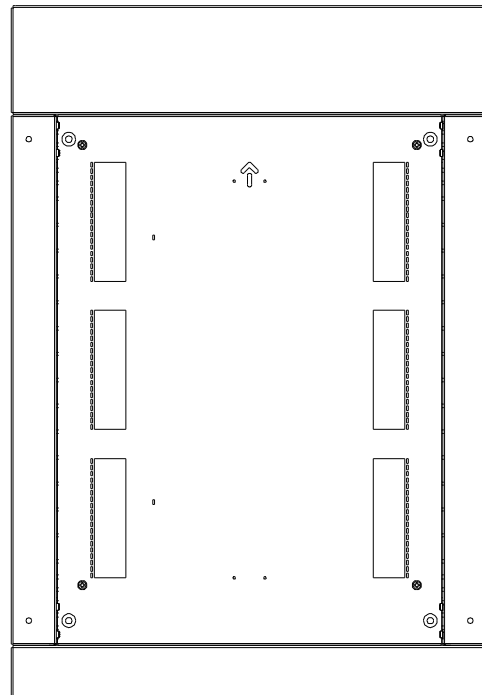

Mounting frame FXM-RMFW

Esmi FXM-RMFW

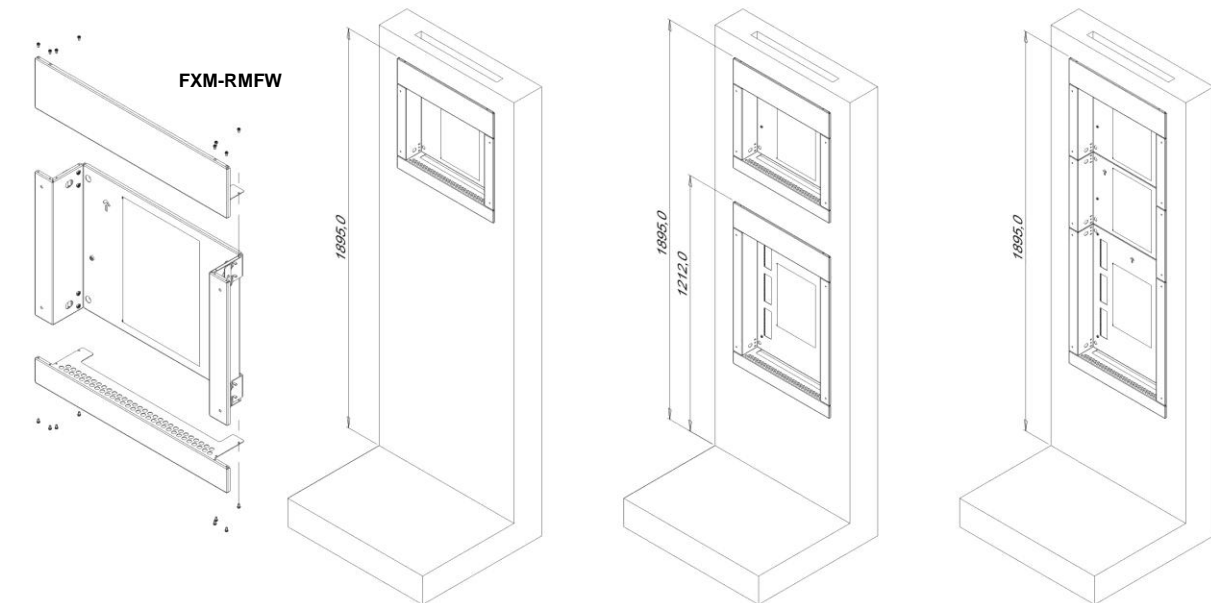
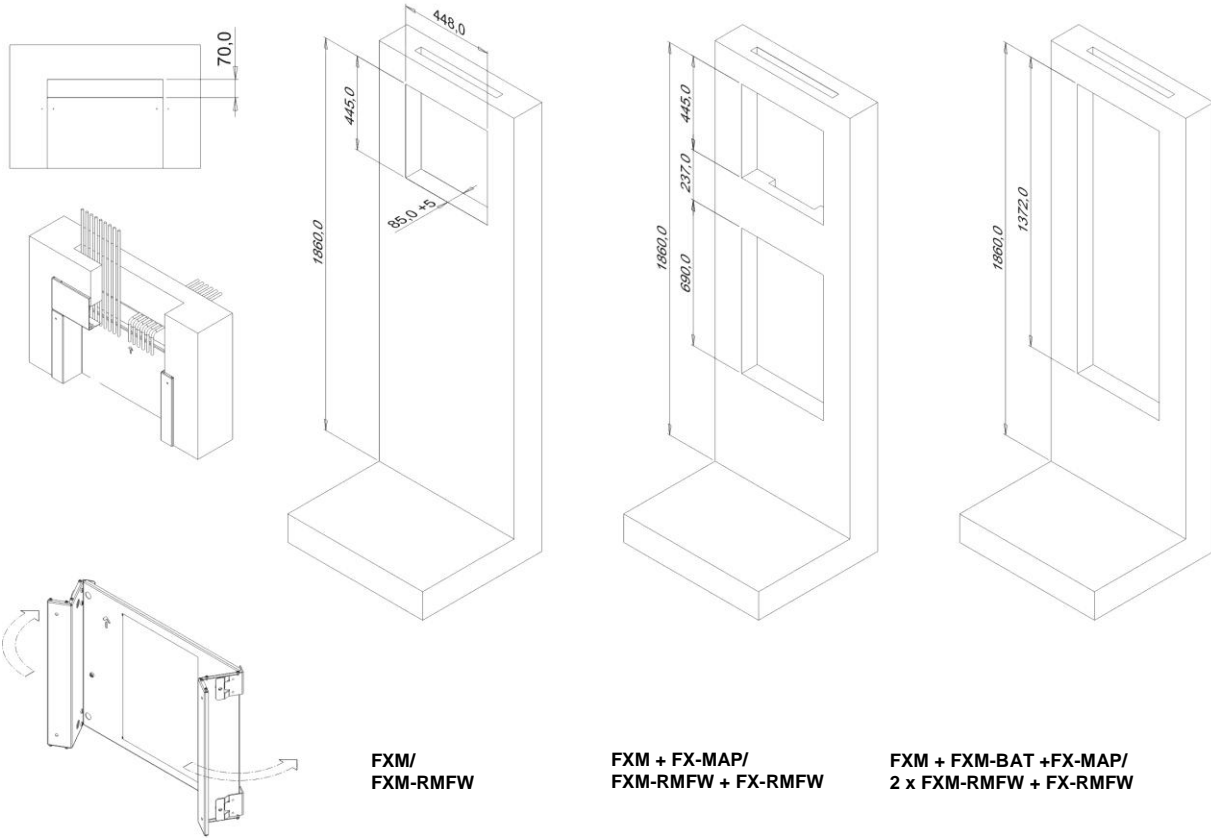

66521522

Mounting frame FX-RMFW

Esmi FX-RMFW

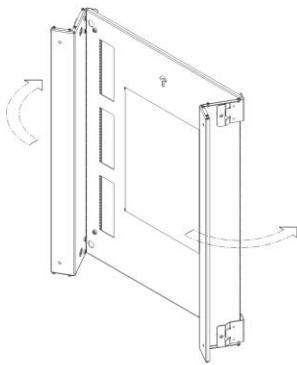
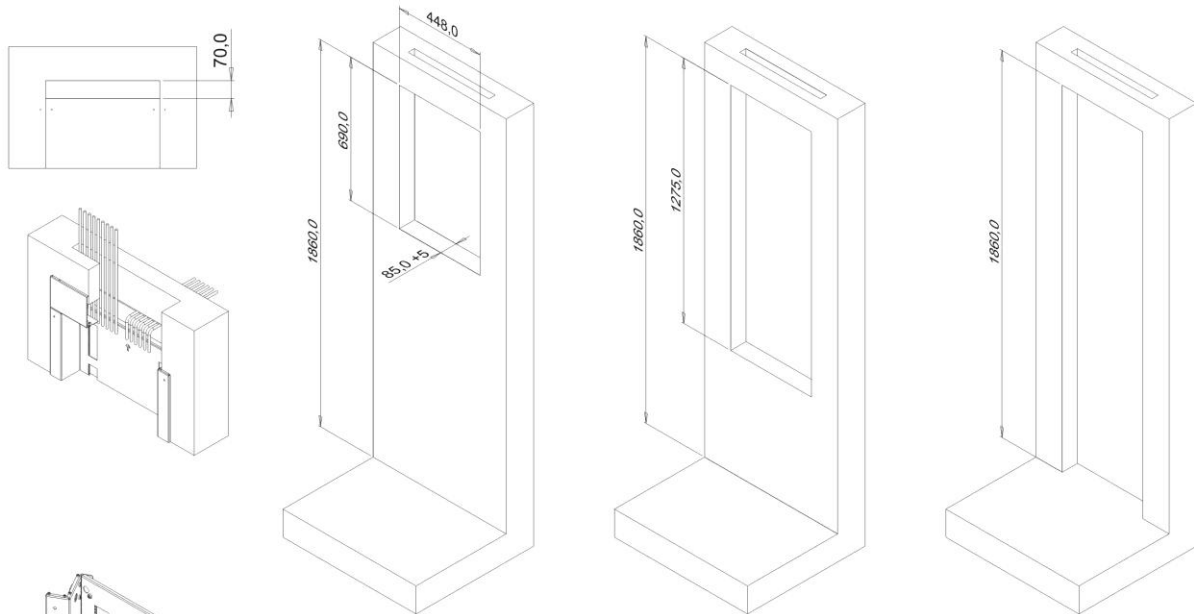

FX/  
FX-RMFW

FX + FX-MAP/  
2 x FX-RMFW

FX + FX-MAP + AX/FXIX-BAT/  
3 x FX-RMFW

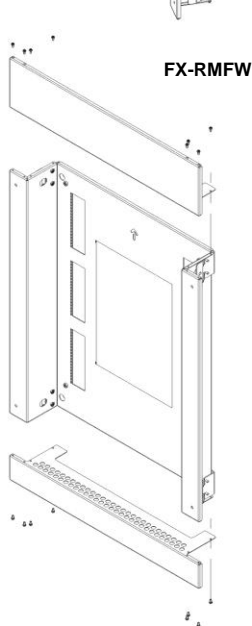

FX-RMFW

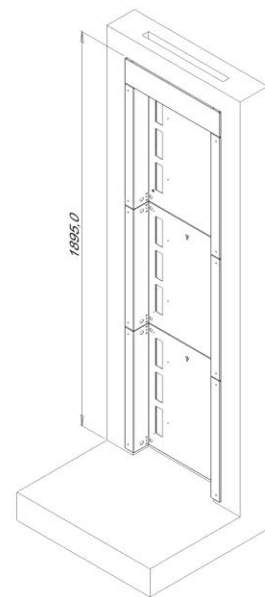
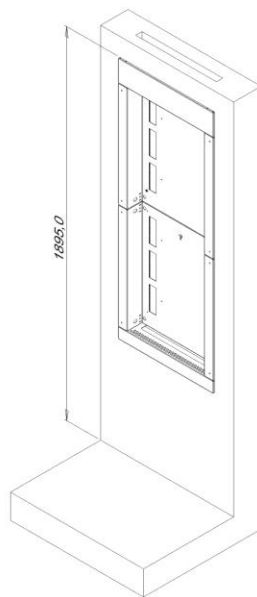
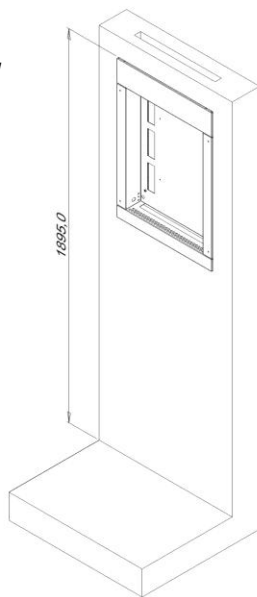

66521478

## Technical and logistic data

## Mounting cabinets

Feature	FXM-CAB	FX-CAB
Dimensions	424 x 335 x 127 mm	424 x 578 x 127 mm
Weight	3,3 kg	6,5 kg
Color	NCS S5020-R80B	
Product code	FFS0070 4615	FFS0070 4610

## Battery cabinets

Feature	FXM-BAT	AX/FX/IX-BAT
Dimensions	424 x 335 x 127 mm	424 x 578 x 127 mm
Weight	3,7 kg	6,8 kg
Battery space	4 x 12 Ah	4 x 17 Ah
Color	NCS S5020-R80B	
Product code	FFS0070 4605	FFS0070 4600

## Mounting frames

Feature	FXM-RMFW	FX-RMFW
Dimensions	527 x 521 mm	527 x 765 mm
Weight	3,9 kg	5,4 kg
Color	White	
Product code	FFS0070 2582	FFS0070 2577

## Chart cabinet

Feature	FX-MAP
Dimensions	424 x 578 x 127 mm
Weight	8,9 kg
Color	NCS S5020-R80B
Product code	FFS0070 5630

## PS2 Power Supply Accessories

Product code	Type	Description
FFS00702548	FX-PS2BM	FX 3NET Battery Monitoring
FSS00702553	FX-PS2TM	FX 3NET Temperature Measurement