

CATALOGUE #2

→ VIDEOINTERCOMS → IP → ACCESS CONTROL → TELEPHONY

we know the value of communication



FARFISA

INTERCOMS SINCE 1967





***we know
the value of
communication***





Index →

page

24

**DUO
System**

- door panels
- internal stations
- 2-IP gateway
- doorkeeper
exchanger
- power supplies
& accessories
- kits
- configurator /
compositions Alba

page

50

**IP and Home
Automation**

- IP and Home
Automation

page

56

**Pluggy
technology**

- videokit
- internal stations



page

60

**Mycom
and Telephony**

- Alba 3G
- kits
- PABX
- intercom-telephone
interfaces

page

66

**Access
Control**

- proximity
readers
- access control
keypads

page

72

**Reduced
Wiring**

- door panels
- internal stations
- power supplies
& service modules
- kits

page

86

**Conventional
Wiring**

- door panels
- internal stations
- power supplies
& service modules
- kits



Welcome
in Farfisa

Welcome in Farfisa! The only headquarter with production dept, office, R&D, showroom, admin is located in Osimo (AN) Italy: warming and sharing are our key words.
Come in and discover Farfisa world!



50
years
1967 / 2017



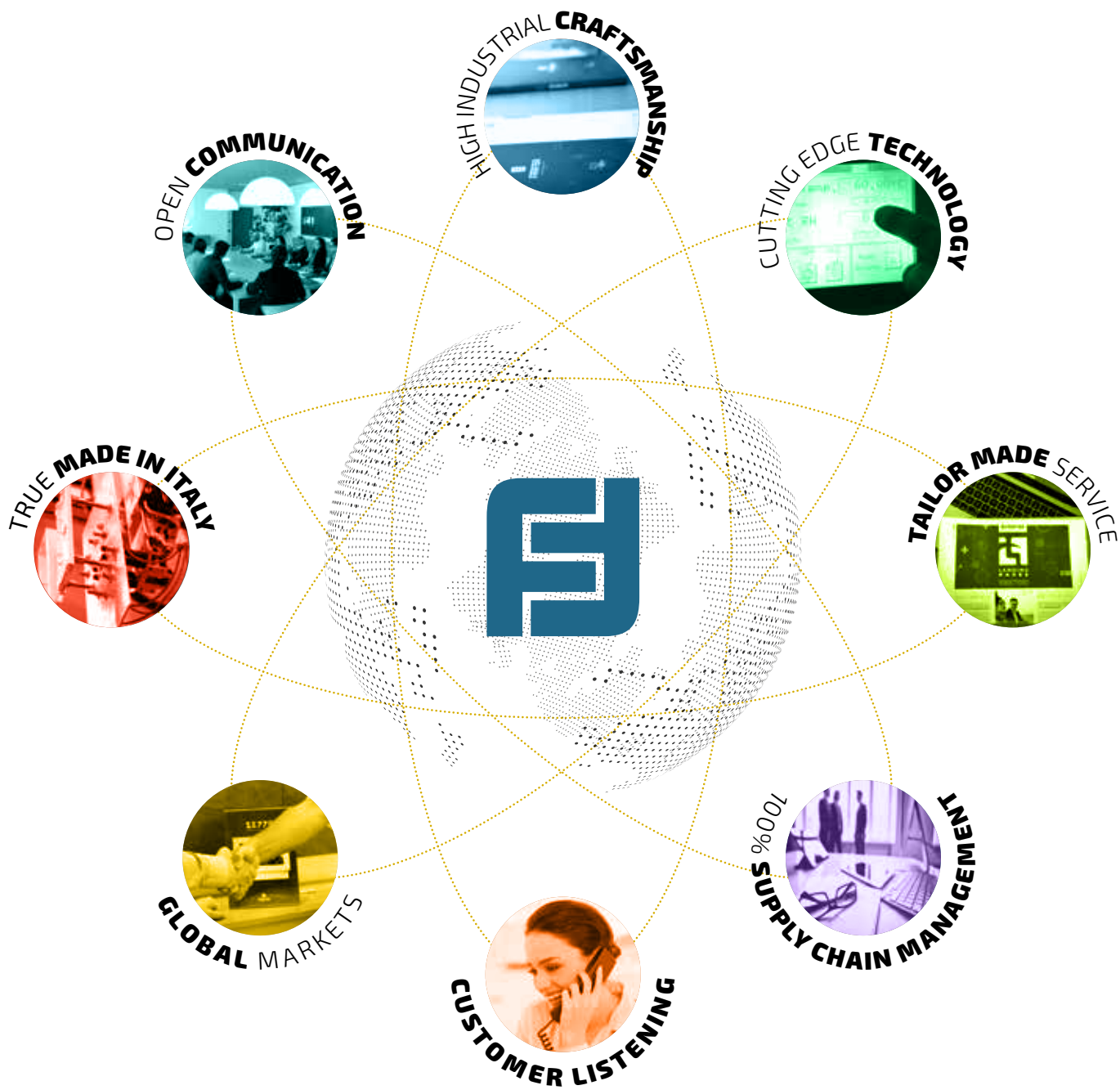

FARFISA

AT THE HEART OF COMMUNICATION

*Farfisa is synonymous with a dynamic and evolving company that integrates different areas in one world: under the direction of the General Management, the Sale Area together with Marketing monitors the target, - with R&D the best technologies - always listening to the market that in the various conjugations responds to the name of Client: **electrical distributor, importer, installer, designer or end user, Farfisa provides top solutions to all and also offers Customer Service and After Sale Service always at the top, with real and competent people.***

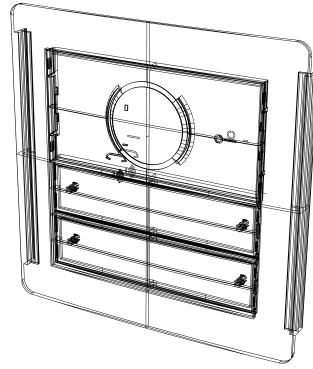

High level technology

HOW

Everything involved with Farfisa correspond to High Level Technology, Superior Quality Handcraft Industry, completely Made in Italy.

True Made in Italy

WHERE

Production, project, services: the whole cycle takes place in our factory. Also in the selection of suppliers, we prefer the best local ones. Efforts, energy and quality are seen and worth: this is True Made In Italy!

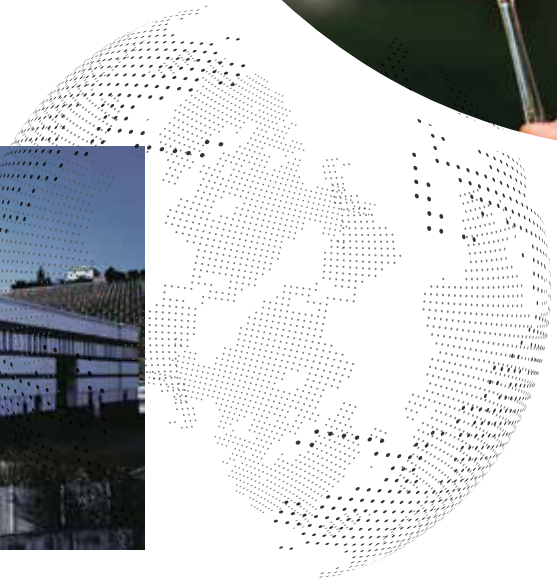

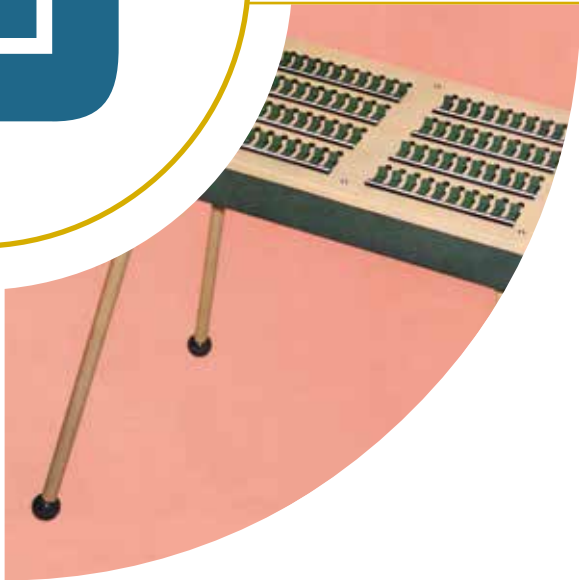

Quality solutions in the world

WHAT

Top quality solutions and configurations responding to customer requests, even specific "tailor made" results. Important installations and large complexes solved with Farfisa implants at every latitudes and geography. The true made in Italy appreciated in the world for quality, technology, service.

History as part of us

WHEN

The Intercom company was founded in 1967 as Division of the historic Farfisa musical instruments and since then, experience and know-how for technology and daily applications of our devices made us a solid entrepreneurial reality that offers solutions to the world.

Goods	Applicant	No. of Application	Date
Musical instruments including electric, electronic and mechanical musical instruments, mechanical, electrical and electronic apparatus for use with musical instruments and parts and fittings for all the aforesaid goods; recorders, amplifiers, loud-speakers, all basic musical instruments of parts of musical instruments	FARFISA S. P.A.	3210,998	14.0.07 15

(Registration of this trade mark shall give no right to the exclusive use of the letters "F")



Musical instruments (except automatic and coin-operated).



SAFE CLAIMED SECTION (109) Italy 20/1/16

SEARCHED	3 JUL 1967
INDEXED	13 FEB 1970
SERIALIZED	30 MAR 1974



CASE HISTORY

Hereby we introduce important projects, special for different reasons: power, wideness of the installation or because we were able to satisfy a particular request of the customer. Yes, correct, **problem solving and customization are our points of strenght**: carefully listening to the customer, we analyze and plan a solution, sometimes really "**tailor-made**" for that specific installation.

PROJECT

Listening the description of the customer' request. In this phase people communicate needs and specifications: relationship between Farfisa and the customer is at top.



48

Guatemala City - Guatemala

Edificio Caprese

Video system with **digital Duo System** composed by 3 Solvo outdoor stations and **48 apartments**, each with 2 EX3262C **monitors**, divided on 2 independent risers, with PDX2000 **switchboard exchanger**, 20 2281Q actuators for integration with elevators. The luxury system requires the "elevator" function and calls through "alias" without neglecting elegant image, reliability also in "turn-key delivery" and made in Italy. **There, Farfisa system configuration is customized.**



+2550

Jeddah - Saudi Arabia

Al Raidah Housing Complex Project

Extended residential complex located on the outskirts of Jeddah, with Farfisa video door entry system with **Duo System technology**. System consisting of **74 towers**. **74 Solvo video door entry units and 2556 ZHeroS internal units**: these are the impressive numbers of the Jeddah plant. The project has seen a considerable change in the specifications after the work has started, in fact the client has decided to prefer a video door entry system to an audio system that they had already started to install.

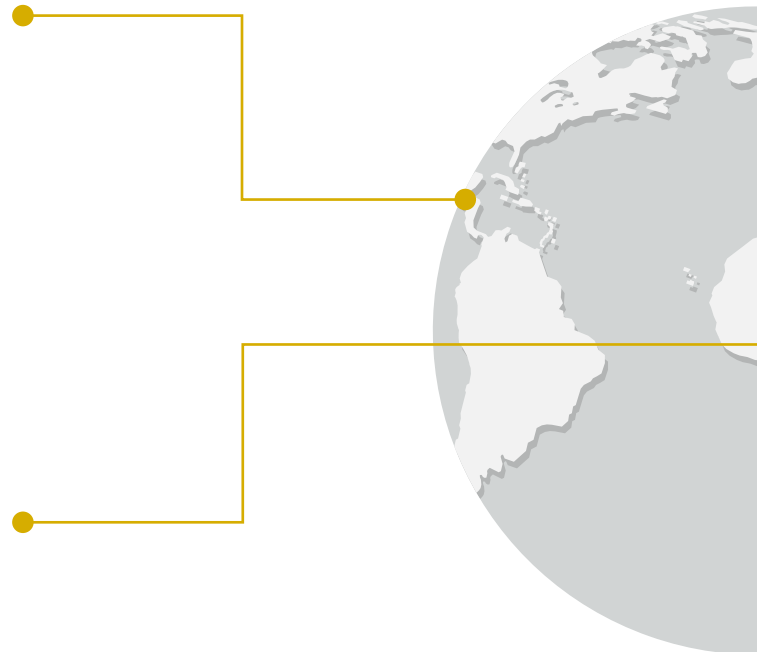

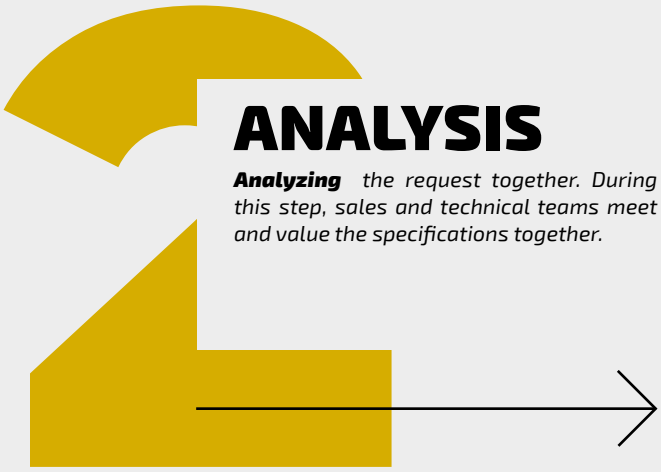

ANALYSIS

Analyzing the request together. During this step, sales and technical teams meet and value the specifications together.



SOLUTION

Offering **Farfisa Solution**. The Company is able to select amongst its catalogue and offer the corresponding proposal or, in case the project is worth, the Corporate will supply the customized solution, perfectly adherent to the requests.



 + **1400**

Dublin - Ireland

Honey Park
Dun Laoghaire, Co.

Video system of more than **1400 users**, solved with digital Duo System technology and composed of **Solvo** outdoor stations and EX352 indoor stations with **PDX2000 switchboard**. The large volume installation in terms of number of users and distances required integration with solutions that provided accessibility to the world of disabled people as a must and also compatibility in integration with the alarm system already provided: Farfisa dedicated solution with Duo System

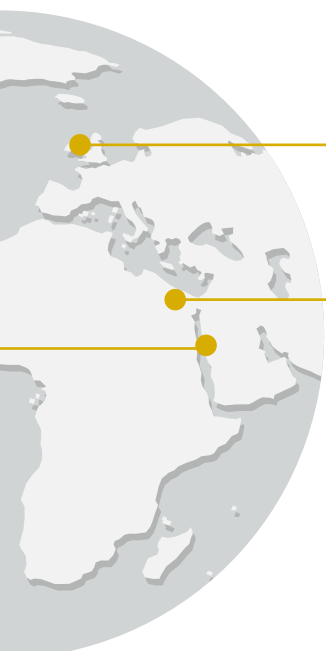

 + **2800**

Cairo - Egypt

Elkhmail Compound,
October City



A stone's throw from Cairo, we operate in the Compound Elkhmail, an important building complex currently in progress whose plan includes **more than 400 buildings** (both residential, business and commercial buildings), in which Farfisa was awarded the contract for the plant audio and videointercoms. The specifications are: guarantee of security and maximum reliability, flexibility in solutions and precision in deliveries. The challenge is fascinating, the offer and the times, compliance with the agreements must be perfect. Farfisa offers flexible solutions entrusted to the Duo System technology that solves safety problems, distances, high number of users.

DESIGN MANUFACTURING GROWING-UP

Skills, Technology, Service

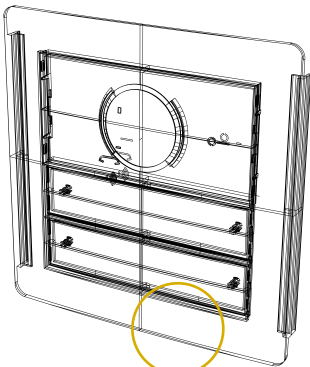

Research & Development

The right mix of **Skills, Professionalism, Team Work** helps to create the ideal atmosphere for a **successful dynamic and open Research & Development department**: sharing ideas towards common objectives by exploiting reliable and consolidated product engineering.



Manufacturing

The flagship of the company is a group of people within the headquarters of Osimo (AN), which are precise and punctual, compete in production with some of the main multinational Corporates in the world. The selection of the best raw materials, co-operation with excellent suppliers, involvement and the motivation of the production department always lead to excellent product results: **compare the quality and choose the value of the True Made In Italy!**

MANUFACTURING

DESIGN

SERVICE



Service

Real, prepared, ready people are available every day, they respond to market demands, we are talking about Customer Service and Technical Sales Service.

Precious services alongside the numerous online services on www.farfisa.com. The staff of the Customers Service aims to provide the best in logistics, locally and worldwide, in the best way and specific for each kind of customer and geography. The Technical Sales Service team listens requests or eventual critical issues suggesting solutions even customized, for maximum satisfaction of the customer.

ONLINE SERVICE
www.farfisa.com

Training

Meetings, direct training moments, webinars are the heart of the Farfisa network staff training in Italy and worldwide, we always co-operate with qualified and professionally trained staff available locally; this is the only way to become Farfisa Authorized Service Centers. In parallel, on the website complete and dynamic technical materials are available: **technical sheets, manuals, installation diagrams, video tutorials and technical interviews, brochures and catalogues.**



TRAINING



TUTORIAL

PROBLEM SOLVING

/ some applications



→ **Big Buildings**

The Duo system allows numerous applications, from single-family up to 20,000 users, with multiple performances and all with ease and speed in the installation and management of the system. **Even for renovations, large distances** are guaranteed, integrations with **video-surveillance, switchboard exchanger** and, with the integration of the gateway module, even more advantages, starting with the **video-call and access control on smartphone!**



→ **One-way villas or small buildings up to 4-users**

In the videokit with Pluggy technology (up to 4 users) you will be able to reach maximum simplicity and the **best value for money with elegance, design and user-friendly use**, signed by the most prestigious Farfisa aesthetic lines.



→ **Large distances with no wiring**

MYCOM: MyCom audio system allows systems with **the door panel only**, great for **no limits in distances**, because the installation is wireless. Communicate and **manage access even remotely**, with programming via SMS, USB or web applications.





FARFISA TALKS TO YOU

*Connect with us
we Listen To You, we Talk To You*

The customer is our "hobbyhorse". The relationship with the customer it is always precious, this is why most of our energy is dedicated to listening: listen to requests to analyze the possibilities and how to suggest appropriate solutions, listen to the specifications to satisfy the demands, listen to any complaints to solve in the best way. We give various tools to contact us, but what is more Farfisa are people: **NO to automatic telephone numbers, yes to a valid network made of people who answer!**

Communication for us is talking daily, sharing experiences, research, news, these are the reasons that led us to **increase the media channels**: website primarily, then newsletters, social, app and - why not? - the phone again!



LANDING PAGES
house magazine



newsletter



tutorials



do you know that



LinkedIn



youtube

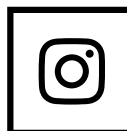

instagram



facebook



Go to
www.farfisa.com/en
and discover
all the news!





WELCOME ITALIAN BEAUTY

- **elegance**
- **modularity**
- **flexibility**

Farfisa is proud of Alba; it represents a goal, its name means Sunrise in Italian, a shining and appropriate name for a new entrepreneurial spirit and new industrial visions.

Totally **Made in Italy** Alba stands out for its high-level design conceived for the best Farfisa technologies. **Modularity and flexibility**, concealed structural elements, luminous icons and attention to accessibility make Alba the line of entry door stations that gives you the composition you need with maximum ease of installation, the top of usability, configuration and updating.

The range consists of individual modules that coexist in compositions: **audio-video or only audio button module** (elegant and compact, allows up to 4 calls with a single module), **module for digital keypad or access control or expansion for MyCom system**, **display module or proximity reader module**. Accessories and various additional elements complete the range.

Alba stands out for its **sensitivity and attention to the disabled**: the wide angle of the camera pushed to allow people in wheelchairs to be framed; printing on the call button is in relief in Braille, for the recognition by the blind; the flashing signal of forwarded call helps the hearing impaired users; it can be equipped with a specific coil to facilitate compatibility with hearing aids for hearing impaired users.

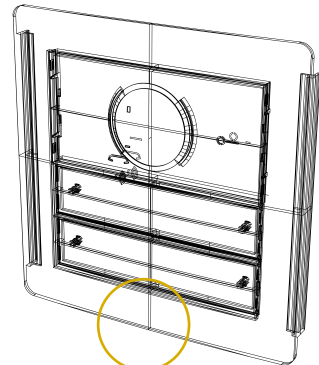

*more
modules
more functions*





ALBA



WELCOME ITALIAN BEAUTY

The front plate is made of anodised aluminum with brushed finishes, color camera with a 2.3 mm focal length and wide-angle lens, camera-integrated loudspeaker and microphone in the lower part not visible, particularly protected internal mechanics and electronics, therefore weatherproof, IP55. The 3 LEDs light up the icons to indicate the status: call sending, busy, active conversation, door lock release. Alba has 2 independent outputs for lock activating and other loads, assembly is simplified and quick and the push-button panel on Duo System is self-powered with automatic address learning. Alba manages the extended range Duo system, so it can be used as the main external unit of **the systems for up to 20000 users** and with **very long distance** between external and internal units. With flush or surface mounting, Alba is also suitable for renovations thanks to compatibility with Farfisa series and others.

Alba can be programmed and managed through **Bluetooth technology** for an higher confort, speed, reliability and usability for the installer and for the end-user too.

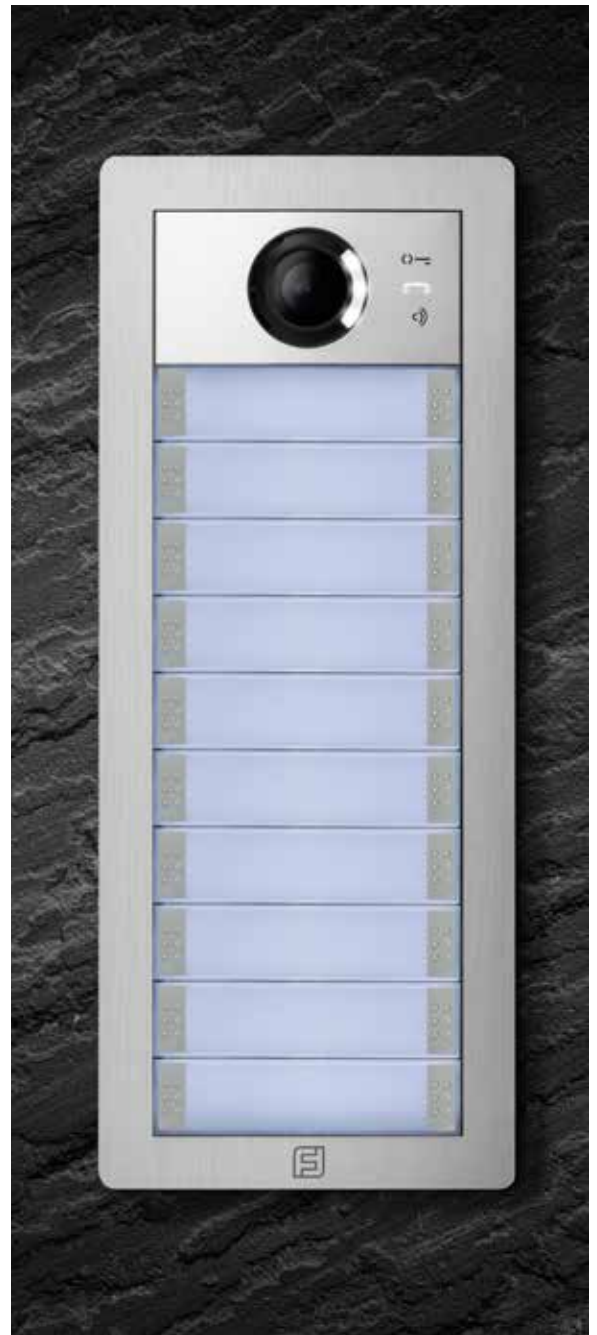

ALBA

ACCESSIBILITY



→ the **wide angle** of the camera to allow people in wheelchairs to be framed



→ the flashing signal of forwarded call helps the **hearing impaired users**;



→ printing on the call button is in relief **in Braille**, for the recognition by the blind;



→ it can be equipped with a specific coil to facilitate compatibility with hearing aids for **hearing impaired users**.



modularity

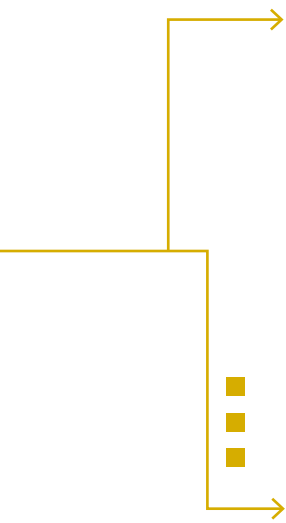



ITALIAN VIEW

- 7" screen
- sophisticated and distinctive design
- hands-free
- touch buttons

Farfisa is proud of **Sette**, the **7" screen videointercom** series. The **design** is extremely rigorous: slim, carefully balanced lines define an ultra-flat monitor conveying a gracefully elegant and light impression, thanks to the attractive sharp profile with 45° edges, coupled with a distinct character enhanced by the step separating the display from the controls area.

The range is named 'Sette' and '**Italian View**' is its payoff, because it shows the broadest possible view for maximum security. The screen is 7" and is of guaranteed quality thanks to the customary 100% Italian design and manufacturing.

LED-lit icons, soft-touch buttons and controls on the graphic interface allow for managing the advanced video door entry for the digital 2 wire **Duo System** and **Pluggy technology**, respectively with the following monitors: SE4Z52W and SE7PG specific for 1SEPG videokits.



High level Design

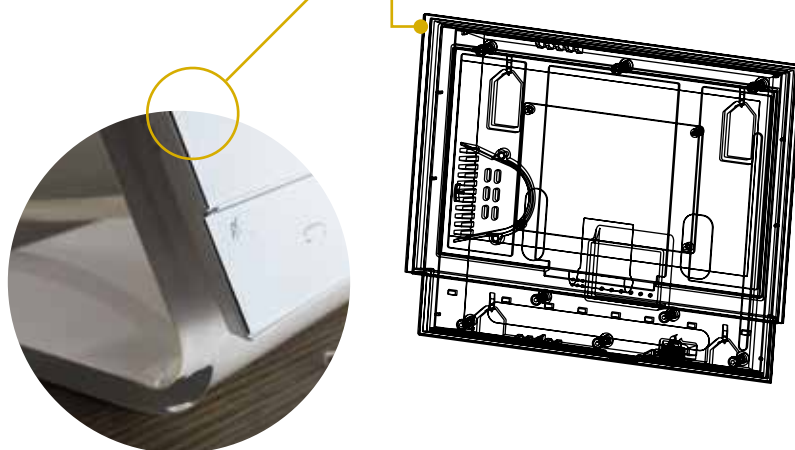

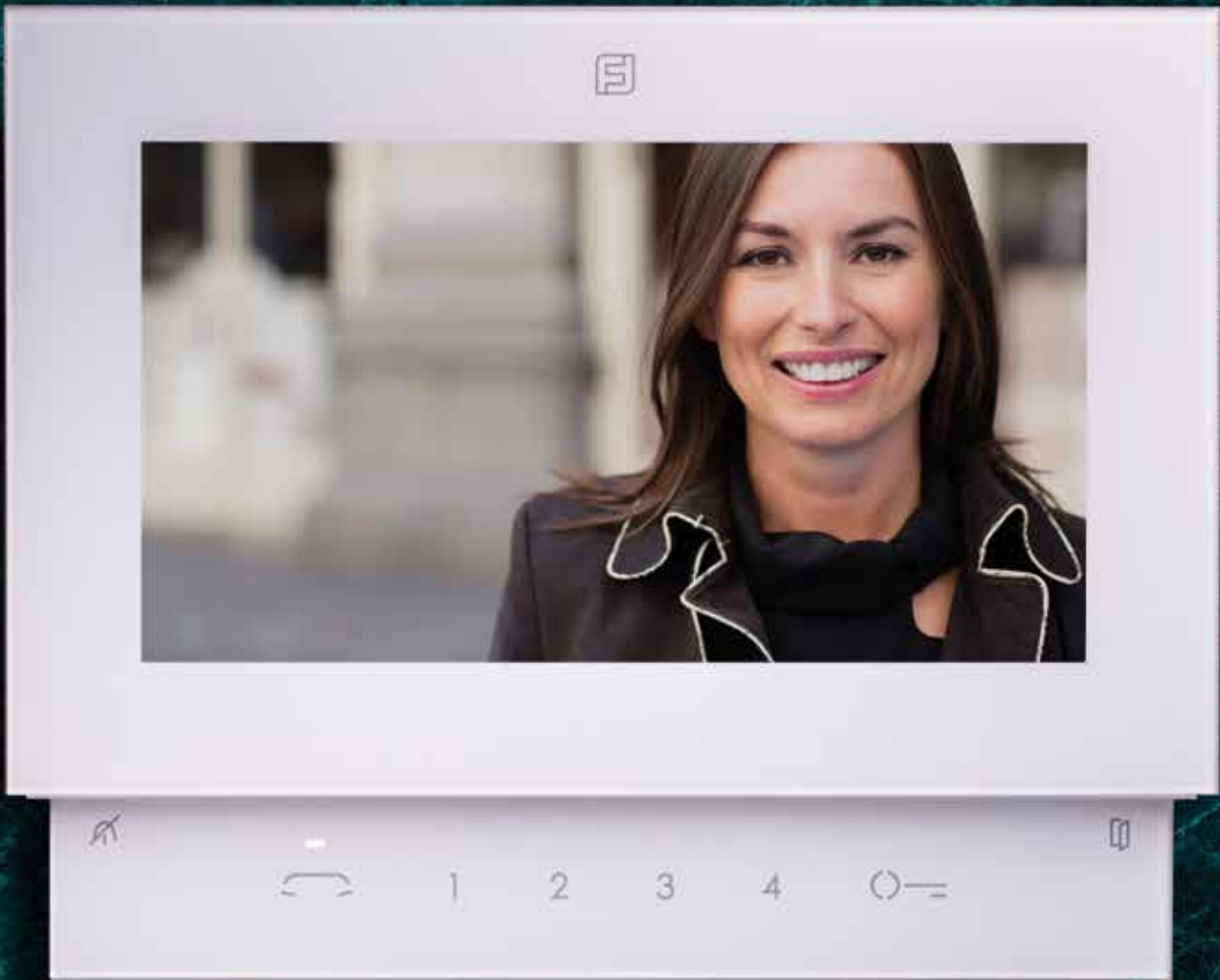

SE77E
ITALIAN VIEW



THE SOLUTION THAT TENDS TO INFINITY

SOLVO

- **solidity**
- **bigger display**
- **accessibility**
- **integration
in a single module**
- **configurability**

Compact, **solid and practical**, designed to serve even large residential estates and big apartment blocks.

With SOLVO Farfisa offers a real solution for a modern and reliable digital video entry door station: **ease of installation and functional extensions** already clearly visible in the structural characteristics, evident in installation technology and perceptible in the offered plus.

Solvo manages the extended range **Duo system**, so it can be used as the main external unit of the systems for **up to 20000 users** and with **very long distance** between external and internal units.

Supplementary features include the camera with wide-angle lens and signalling LEDs in a single complete module (4 versions available: audio-video, audio only, with or without RFID configuration) that satisfies the most diverse requirements.



new!

HERO

NOBLE TECHNOLOGY ADVANCED FORCE

- **top antivandal**
- **max accessibility**
- **forefront performance**

The new HERO door panel offers the top in terms of **technological performance, security**, using top-level materials and finishes, offering excellent solutions as regards **accessibility** to the world of disabled people. The line consists of a single element: a large panel made of 316L **stainless steel**, with large steel keys and 6 Torx security screws, for flush mounting, they help guarantee the **vandal-proof** by combining the best ergonomics and maximum technological performance.

To the touch, the sensation is robustness and elegance together, cold and smooth, modern and reliable.

Hero will capture you.

Hero is designed for **Duo video systems with bus power supply**, Hero manages the extended range Duo system, therefore it can be used as the main external unit on systems with up to **20,000 users** and with **maximum distances** between external and internal units.

Ideal for large complexes, it has a digital keyboard consisting of 14 large keys, backlit also in the outline of the button, very large and backlit graphic display, wide angle camera, status icons and various pluses that make Hero a top level of accessibility to the world of disabled people. Hero manages up to 500 users with individual passwords, it is ready for mechanical assembly of any proximity readers. Among other features we highlight the **voice prompt** and programming is possible via **Bluetooth**.

ALCANTARA

THE SUBTLE ART OF COMMUNICATION

- modular conception
- reduced dimensions
- good quality/price ratio

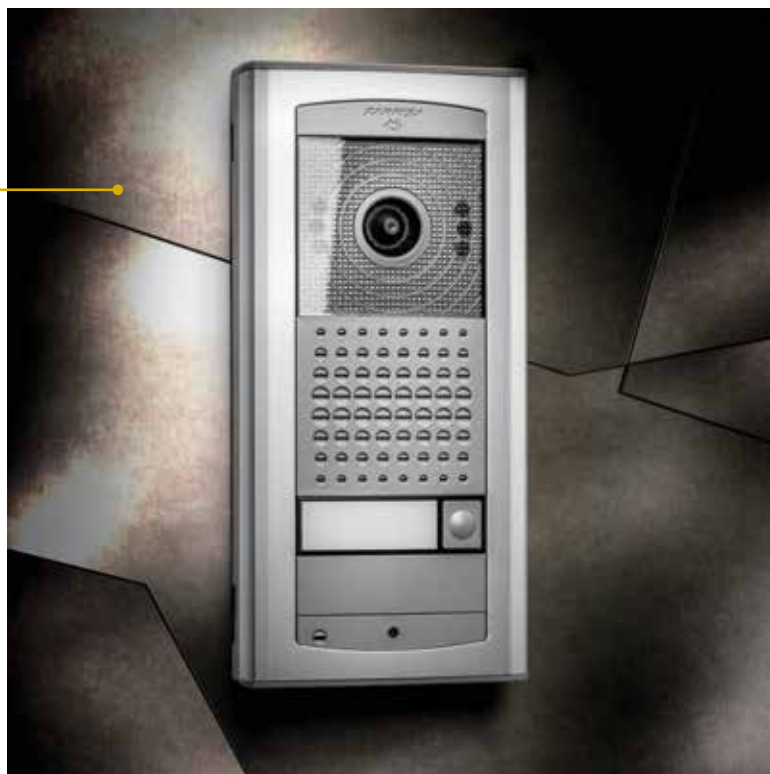

MATRIX

THE STRENGTH OF STYLE

- guaranteed anti-vandal
- elegance
- modularity
- even for high number
of users

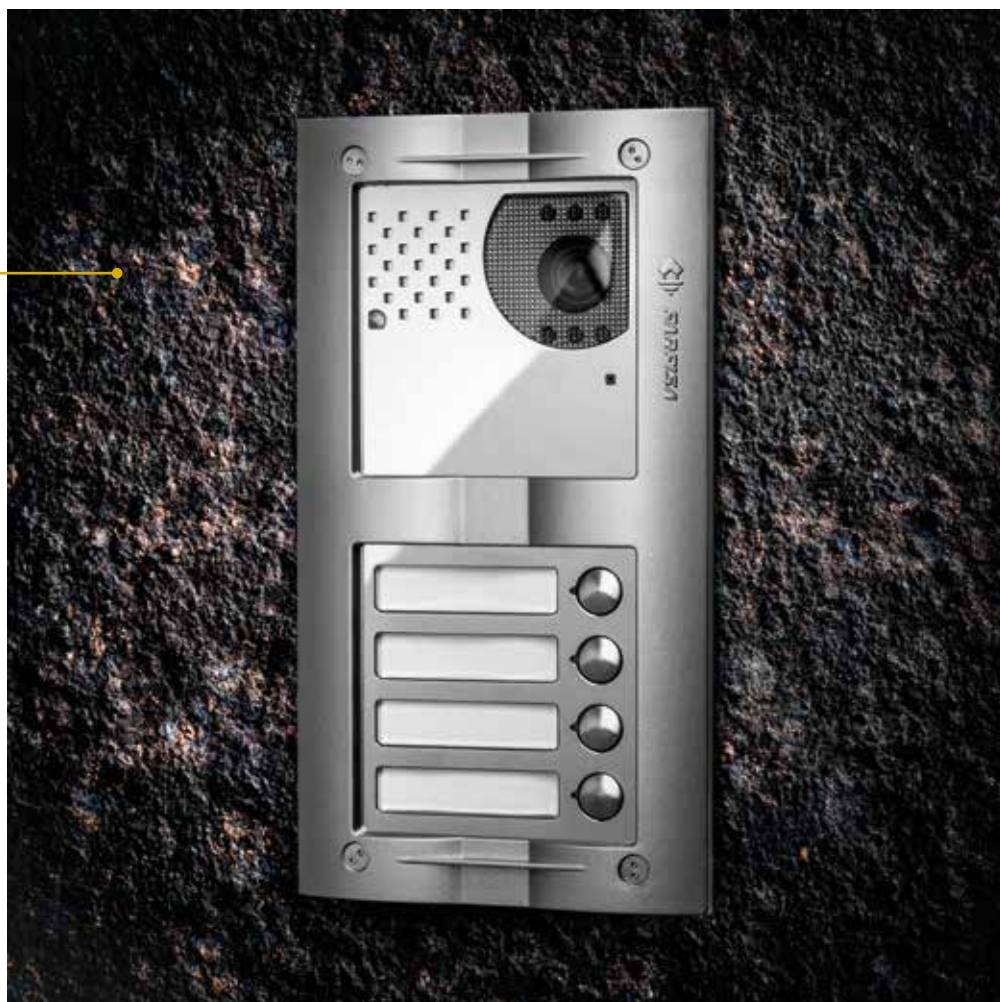

new!



ZHERO

**ZHERO SPACE,
ZHERO LIMITS,
ZHERO ALTERNATIVES**

- *hands-free*
- *elegance & design*
- *backlit icons*
- *advanced personalisation*

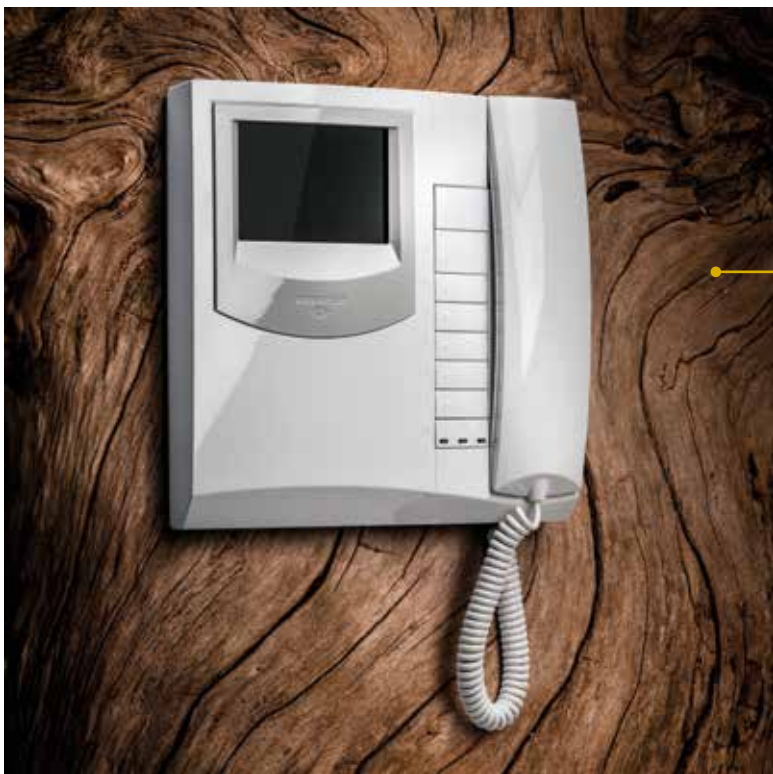

Exhito

**RELIABLE TECHNOLOGY SUITABLE
TO ANY INSTALLATION**

- *apparatus with handset*
- *wide offer range*
- *the best quality/price ratio*

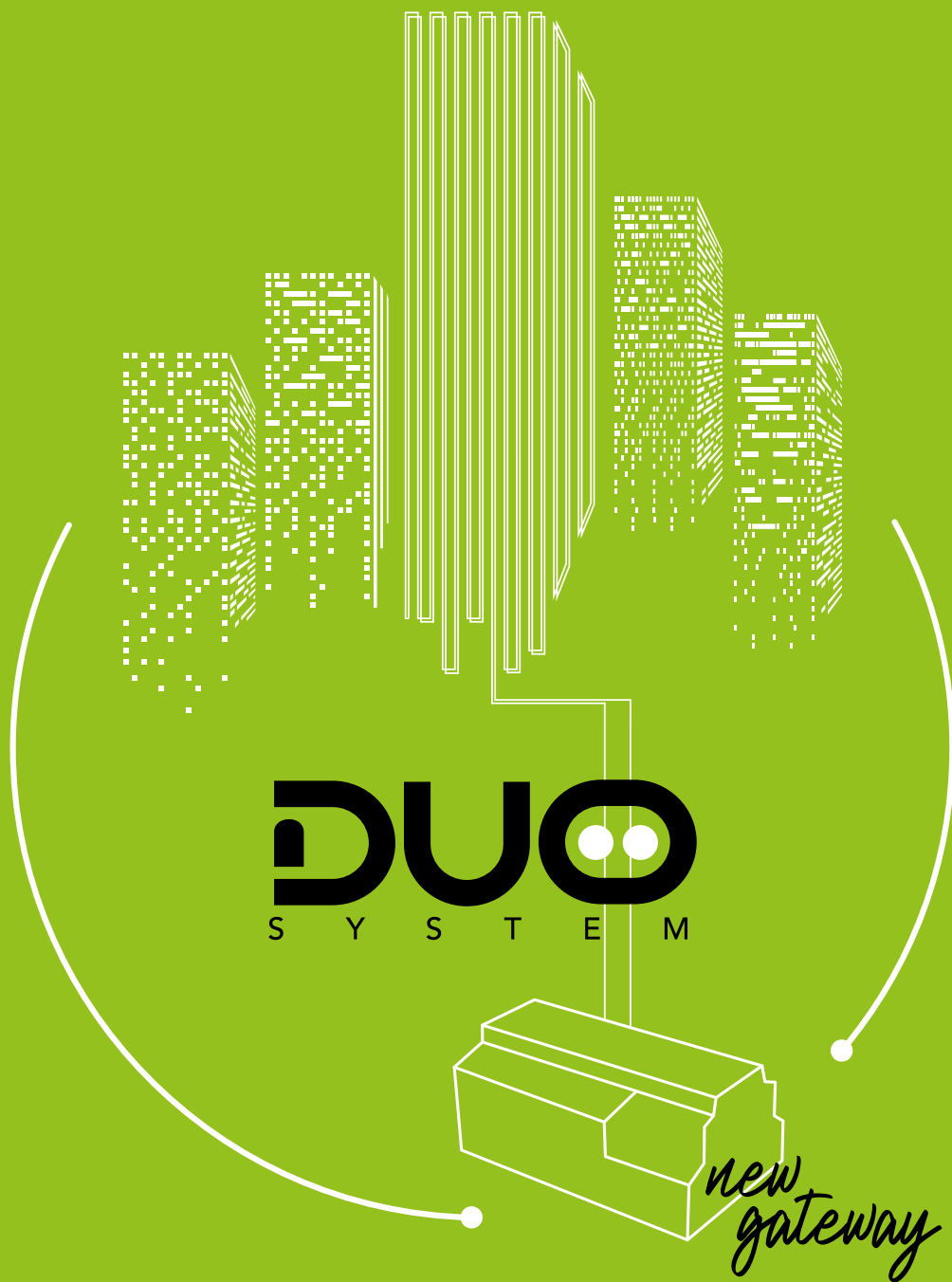

**“Exponential
communication”**



28 door panels

- 28 *Alba*
- 31 *Hero*
- 32 *Solvo*
- 33 *Agorà*
- 34 *Profilo*
- 36 *Matrix*

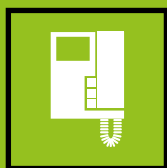

38 internal stations

- 38 *Sette*
- 40 *ZHero*
- 41 *Exhito*



42 gateway



44 doorkeeper exchanger



44 power supplies & accessories



46 kits



47 configurator / Alba compositions

DUO

S Y S T E M

Duo System, the digital videointercom with 2 non-polarised wires, continues to evolve, now we are in front to a really competitive evolution: the advent of the GW2IP gateway allows enviable performance guaranteed by the top of Farfisa R&D. The Duo bus in fact integrates with the IP network, opening new frontiers without borders.

Duo System is a 'pure 2-wire' system, thanks to the new **ALBA**, **HERO**, **SOLVO** and **AGORÀ** push-button panels. Like all the other components adopting this technology, they are powered directly by the 2-wire bus, which further optimises the installation phase. As always, also **PROFILO** and **MA-TRIX** series are available.

Duo System proposes as internal stations **Sette** range with 7" screen, the various versions of **ZHero** and **Exhito**. Max number of users is 20.000, an important upgrade on the system, reached even thanks to 2231Q separator.

Further performances, more and more requested and therefore enhanced: the integrations with the Video surveillance systems, which reach a level previously unthinkable thanks to the modulator, as well as those with Telephony, thanks to FTDUO. Important supports are given by **Bluetooth technology**, available for the comfort of the installer and the user. **Duo System can be adopted with:**



door panels



ALBA



SOLVO



HERO



AGORÀ



PROFILO



MATRIX



internal stations



SE77E



ZHERO



Exhito



gateway



doorkeeper exchanger



videokits



CCTV



“EXPONENTIAL COMMUNICATION”

Plus

Installation example



→ Gateway IP gateway EVOLUTION iP way



→ self-powered external door stations: two pure wires



→ extremely easy assembly = saves time and money



→ Bluetooth for access control and management and setup of the system



→ Performance optimised for telephony



→ Increased number of users: up to 20,000



→ Doorkeeper exchanger



→ Possibility of smart integration with video surveillance systems



→ Constantly evolving product range to satisfy any need



→ smart cabling for home automation

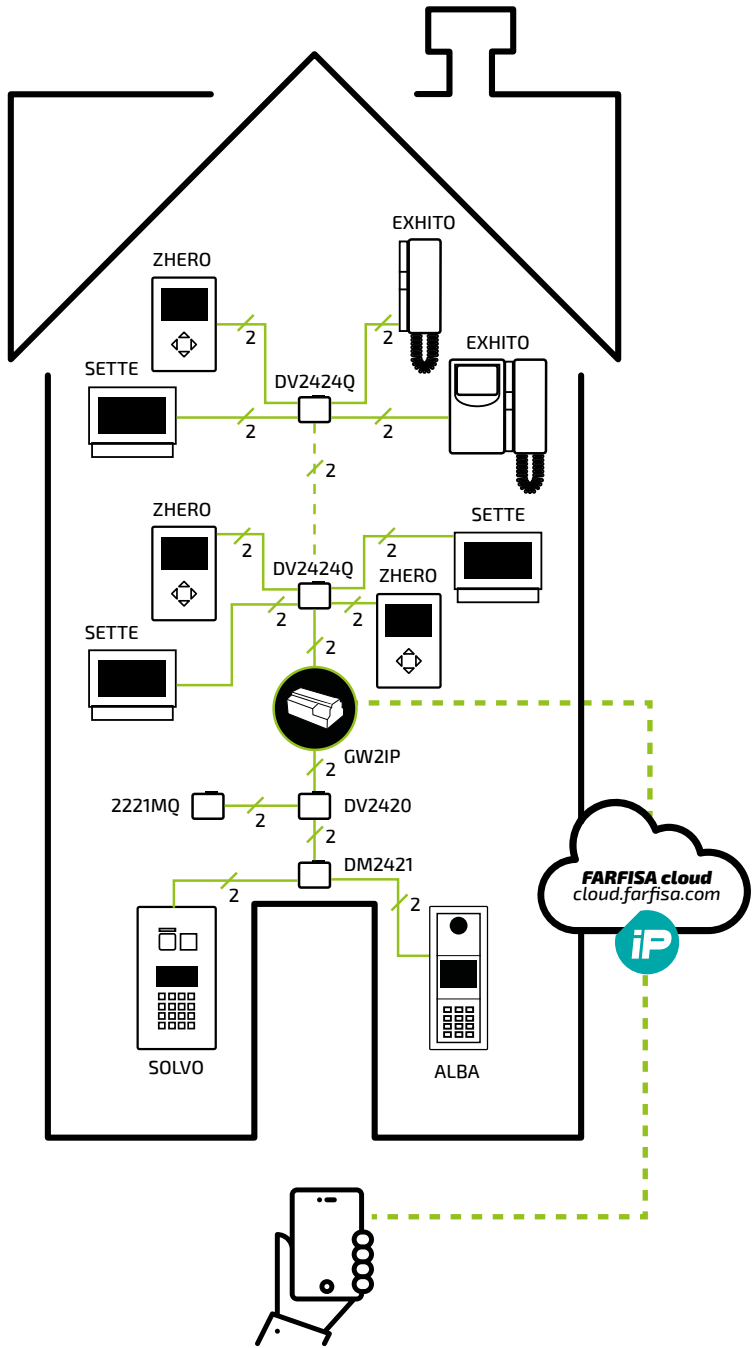



→ door panels

Besides **Alba**, the most flexible and versatile door panel by Farfisa, all the main door panels are compatible with the Duo System. More specifically, there is the latest addition to the range, the strong **Hero**, alongside **Solvo**, the modular **Agorà**, **Profilo** and **Matrix** solutions – all with integrated electric door speaker. With **Alba**, **Profilo** and **Matrix**, calls

can be made through push buttons or through the digital keypad: Duo can now accommodate **up to 20,000 users**. The products have compact dimensions thanks to the modules with 2 buttons on a single row. The fact that **Alba**, **Hero**, **Solvo** and **Agorà** are powered directly by Duo System bus translates into less time required for their installation and even greater savings.

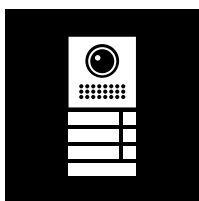

elegance
modularity
flexibility

Alba features superior and refined design, modularity and flexibility are the key words describing a range that guarantees countless usage options. These compact, self-powered modules allow for making conventional or digital calls. Front plate in anodized aluminum with brushed finish. Compositions or standalone solutions with

various elements between compact modules with camera, call buttons, digital keypad or access control, display module LCD, proximity reader and different accessories and elements of installation create a truly comprehensive line for all needs.

audio and video modules



CV2124AB

Dim: mm 99x91x9.

Audio-video module ready up to 4 call buttons. Door speaker and colour wide angle 2.3 mm lens camera included. Powered by the bus.



CA2124AB

Dim: mm 99x91x9.

Audio module ready up to 4 call buttons. Electric door speaker included. Powered by the bus.



ALBA
WELCOME ITALIAN BEAUTY

full performance
more modules / more functions



CT2138AB

Dim: mm 99x91x9.

Button module ready up to **8 additional call buttons**, for combination with CA2124AB or CV2124AB. Auto programming allowed.

digital keypad



PD2100AB

Dim: mm 99x91x9.

Digital keypad module, backlit. It allows the internal call through the coding of the corresponding number and door opening through reserved code. Could be used as a single product for access control or combined with DD2140AB, to CA2124AB, to CV2124AB or to the AB3G. If combined with CA2124AB or CV2124AB, it allows to activate remote actuators. If combined with XE2921, the system clock is used for timed functions. Programming manually or via Bluetooth. It can manage up to 1000 codes, equipped with 2 internal relays.



XE2922

Alba bus expansion board, allows the **integration of Bluetooth technology** in the push button panel. It allows access control simply via smartphone with dedicated app, available for free on the App Store and Play Store. The lock opens via virtual keyboard and personal numeric code or with a simple screen touch, in case the smartphone has been previously associated to the device. For further information on the FARFISA SMART ACCESS app, go to page. 69.

display module



DD2140AB

Dim: mm 99x91x9.

3.5" graphic LCD display module. Electronic index is integrated allowing to scroll and select the single user. It can be combined with PD2100AB keypad, CA2124AB audio module or CV2124AB audio-video module. Max address book capacity: 1000 users.



other modules

AB00

Dim: mm 99x91x9.

Blank module to be used to complete the panel composition.



AB50

Dim: mm 99x91x9.

Street number module.



FP51AB

Dim: mm 99x91x9.

Proximity reader module. Stand alone, it can be combined with other modules and accessories of Alba series. Bluetooth technology. For further information please see page 68 Access Control chapter.

accessories



AB20 - Dim: mm 90 x 22 - **Single button** aluminium blank module. To be mounted on CA2124AB, CV2124AB or CT2138AB.

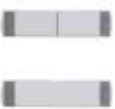

AB21 - Dim: mm 90 x 22 - **Single or double call button**, according to the programming of CA2124AB or CV2124AB. To be mounted on CA2124AB, CV2124AB or CT2138AB. Braille is embossed to make it recognizable to visually impaired users. Backlit with white led.

installation elements



AB61 - Dim: mm 124x124x9 - **Front frame** for **1** module, in anodised aluminium.



AB62 - Dim: mm 124x215,5x9 - **Front frame** for **2** modules, in anodised aluminium



AB63 - Dim: mm 124x307x9 - **Front frame** for **3** modules, in anodised aluminium.



AB71 - Dim: mm 119x119x36 - **Module frame** for **1** module in die-cast aluminium. To be mounted with AB61; in case of flush mount, SC1 is also required.

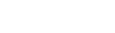

AB72 - Dim: mm 119x210x36 - **Module frame** for **2** modules in die-cast aluminium. To be mounted with AB62; in case of flush mount, SC2 is also required.



AB73 - Dim: mm 119x302x36 - **Module frame** for **3** modules in die-cast aluminium. To be mounted with AB63; in case of flush mount, SC3 is also required.



AB81S - Dim: mm 125x125x30. **Box** for the installation of **1** module of Alba range with surface mounting. In painted metal.



AB82S - Dim: mm 125x216,5x30. **Box** for the installation of **2** modules of Alba range with surface mounting. In painted metal.



AB83S - Dim: mm 125x308x30. **Box** for the installation of **3** modules of Alba range with surface mounting. In painted metal.



AB91 - Dim: mm 140x137x62 - **Rain shelter** in aluminium for surface mounting, **1** module



AB92 - Dim: mm 140x229x62 - **Rain shelter** in aluminium for surface mounting, **2** modules.



AB93 - Dim: mm 140x320x62 - **Rain shelter** in aluminium for surface mounting, **3** modules.



AB94 - Dim: mm 264x229x62 - **Rain shelter** in aluminium for surface mounting, **4** modules (2 double joined).



AB96 - Dim: mm 264x320x62 - **Rain shelter** in aluminium for surface mounting, **6** modules (2 triple joined).



SC1 - Dim: mm 122x119x45 - **Back box** for **1** module.



SC2 - Dim: mm 122x210x45 - **Back box** for **2** modules.



SC3 - Dim: mm 122x302x45 - **Back box** for **3** modules.



EC733 - Alba optional connecting **cable**. It can be used to connect the bottom ALBA module of a row to the top ALBA module of the next row, in case the rows feature 3 x module. In this scenario, its use is mandatory only if it's strictly requested to have an increasing numbering scheme from the top to the bottom of each row of buttons. To be strictly used necessarily only in case you want to keep an address of the keys rising from the top to the bottom of the push button.





new!

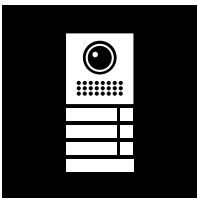

HERO

*top antivandal
max accessibility
forefront performance*



TD2000HE

Dim: mm 205x500x2

Video door entry panel with digital call, a single complete and flexible element. Hero is designed for Duo video systems **powered by bus**, it is ready for integration of a proximity reader. It can manage up to 500 users and their passwords. With plate and 14 keys made of marine-grade 316L stainless steel, Hero is secured by **6 security torx screws** and is installed with **flush mounting** with 61 mm deep box of which Hero is already stocked. **2 independent outputs**: 1 for electric lock and 1 with relay for automatic gate or other lock. **Programming** can be done via Bluetooth, with the Duo app for iOS and Android or through integrated digital keyboard.

It is also an extremely accessible product to the disabled people for:

- **voice prompt** for audio indication of the call or system status (in various languages, deactivated by programming)
- raised, large, backlit **keys in Braille** also evident in the outline, more visible also for the visually impaired
- **large, backlit graphic display**, such as status icons, for optimal reading even in unfavorable lighting conditions
- **wide angle camera as standard**, for greater security and for allow a correct view of any category of visitor
- series integration of inductive **loop** for coupling with devices hearing aids for the hearing impaired



XE2922

Internal **bus expansion** board, allows integration of Bluetooth technology in the door station. It allows access control simply via smartphone with dedicated app, available for free on App Store and Play Store. It opens the lock via virtual keyboard and personal numeric code or with a simple screen touch, in case the smartphone has been previously associated with the device. For further information on the FARFISA SMART ACCESS app, go to page 69.

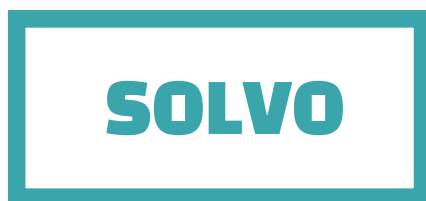
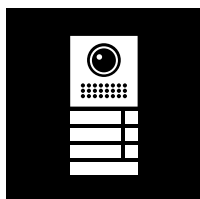

solidity
bigger display
accessibility
integration in one module
configurability

Compact, solid and practical, Solvo is a single module, self-powered, designed to serve even large residential estates and big apartment blocks. A real solution for a modern and reliable digital video entry panel, it already includes

plate made in stainless steel with TORX security screws, backlit keypad, bigger display, signal leds. Wide angle camera (in video models), ready to be mounted with proximity reader and vigik system, in the dedicated versions.

complete door panels



TD2000

Dim: mm 170x306x2.

Digital video door panel. An only element composed by color camera, 16 buttons, 4 icons for system status and alphanumeric LCD. It allows to dial and send calls on digital Duo bus. 3 white led's for camera. Door lock drive time: programmable depending on the needs of the installation, as many other functions.



TD2000RA

Dim: mm 170x306x2.

Digital intercom door panel. An only element composed by 16 buttons, 4 icons for system status and alphanumeric LCD. It is ready to be integrated with **proximity reader** FP2000 module or vigik system. It allows to dial and send calls on digital Duo bus. Door lock drive time: programmable depending on the needs of the installation, as many other functions.



TD2000A

Dim: mm 170x306x2.

Digital intercom door panel. An only element composed by 16 buttons, 4 icons for system status and alphanumeric LCD. It allows to dial and send calls on digital Duo bus. Door lock drive time: programmable depending on the needs of the installation, as many other functions.



TD2000R

Dim: mm 170x306x2.

Digital video door panel. An only element composed by color camera, 16 buttons, 4 icons for system status and alphanumeric LCD. It is ready to be integrated with **proximity reader** FP2000 module or vigik system. It allows to dial and send calls on digital Duo bus. 3 white led's for camera. Door lock drive time: programmable depending on the needs of the installation, as many other functions.

accessories

FP2000 - Proximity reader module, complete with RFID antenna and accessories for the mounting in Solvo door panels, TD2000R and TD2000RA models. It allows to manage access for max 400 users with corresponding cards (FP11/10 or FP12/10). It is provided with a relay (programmable in monostable/ bistable working), with 24Vac/2A contacts, for door opening or other services activation. Programming through button and led, Master Card or PC software. It can be powered by PRS210.

installation elements

290S/0 - Rain shelter in stainless steel for surface mounting of all Solvo models. It allows the installation where the built-in is not required, it allows to guarantee the necessary solidity and mounting easiness. *Dim: mm 174x310x75.*

TL2000 - Accessory coil antenna for Solvo door panel to be inserted into Solvo door station. It allows the compatibility with Solvo door panel and the hearing aid for hearing impaired users.

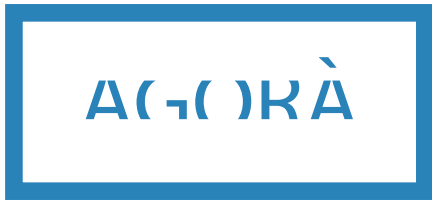
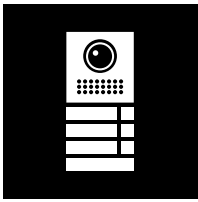

modular concept
reduced dimensions
easiness of use

Agorà stands out for the simplicity of the project: modularity and reduced dimensions (in width less than 10 cm)

with surface mounting allow solutions that meet many requirements, even renovation of installations with various requirements.

door panels



VD2121CAGL

Dim: mm 99x208x30

Module composed by surface mounting box, front plate with frame, cover, door speaker, adjustable **colour camera** with 3.6 mm pin-hole fixed lens and **1 call button**, second button can be added.



AD2101AGL

Dim: mm 99x208x30

Composed by surface mounting box, front plate with frame, cover, door speaker and **1 call button**, second button can be added, no possibility of expansion. Powered by the bus, that allows to simplify the wiring.



AD2121CAGL

Dim: mm 99x208x30

Module composed by surface mounting box, front plate with frame, cover, door speaker and **1 call button**, second button can be added.



accessories

AGL20 - **Blank module.**

AGL21 - **Single call button** module with name - holder.



AGL100TS

Dim: mm 99x208x30

Additional module composed by surface mounting box, front plate with frame for combination with VD2121CAGL or AD2121CAGL to add up to **8 additional buttons**, complete with encoding buttons. Nearby photo with push buttons configuration at maximum extension.



note: Items are available also in dark grey colour.



VD2101AGL

Dim: mm 99x208x30

Composed by surface mounting box, front plate with frame, cover, doorspeaker, adjustable **colour camera** with 3.6 mm pin-hole fixed lens and 1 call button, second button can be added. Max 2 calls, no possibility of expansion. Powered by the bus, that allows to simplify the wiring.

installation elements

WA12AG - Dim: mm 146x254 - **Wall adaptor** including anodized aluminium rain shelter that allows the replacement of an existing built-in Mody door panel (**2 modules**) with a surface Agorà module. It is supplied with holes conceived to cover the previous mountings with MD71 or MD72.

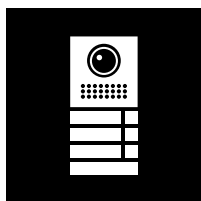

*modular soul
big versatility
even for big number of users*

Compact modular door panel, suitable for situations where space is limited. Anodised extruded aluminium front plate and steel call buttons, with username labels backlit in green to facilitate identification and reading even under poor illumination.

Guarantees a high number of users even with its compact dimensions, thanks to the small size of the single module and the optimised use of space with the double call button.

audio and video modules



VD2120CPL

Dim: mm 99x110x17

Colour audio-video module without call buttons. Camera is +/-10° adjustable in horizontal and vertical with fixed 3.6 mm lens. To be installed joint with CD213...PL module with conventional buttons or with digital TD2100PL module.



AD2120CPL

Dim: mm 99x110x17

Audio module without call buttons. To be installed joint with CD213...PL module with conventional buttons or with digital TD2100PL module.

digital keypad



TD2100PL

Dim: mm 99x110x17

Digital keypad with aluminium front plate and 14 steel buttons. Equipped with LCD graphic display back-lit in green colour and "button 5" raised for easy recognition by blind person. It allows the call to the user by dialling the corresponding number and electric lock release by entering the private code. The electronic index is also integrated, which gives the possibility to scroll the names in alphabetical order and select the desired one. This integration allows to further reduce space compared to the corresponding modular compositions. To be joint to VD-2120CPL or AD2120CPL module. It can store up to 250 user names.

conventional door panels

To be used with video module VD-2120CPL or audio AD2120CPL.

CD2131PL

Dim: mm 99x110x17

Encoder for Duo System with **1 button** for conventional external station, it can code up to 128 users.



CD2132PL

Dim: mm 99x110x17

Encoder for Duo System with **2 buttons** for conventional external station, it can code up to 128 users.



CD2134PL

Dim: mm 99x110x17

Encoder for Duo System with **4 buttons** for conventional external station, it can code up to 128 users.



CD2138PL

Dim: mm 99x110x17

Encoder for Duo System with **8 buttons** on 2 rows for conventional external station, it can code up to 128 users.



PL24S

Dim: mm 99x110x17

Additional buttons module with **4 buttons** for Duo System installations.



PL228S

Dim: mm 99x110x17

Additional buttons module with **8 buttons** on 2 rows for Duo System installations.



PL50

Dim: mm 99x110x17

Street number module.



PL20

Dim: mm 99x110x17

Blank module to be used to complete the assembly.

installation elements



PL71 - Dim: mm 91x133x47 - **Back box with frame for 1 module.**



PL72 - Dim: mm 91x244.5x47 - **Back box with frame for 2 modules.**



PL73 - Dim: mm 91x356x47 - **Back box with frame for 3 modules.**



PL81 - Dim: mm 118x153x41 - **Hood cover for 1 module** in aluminium. To be mounted together with the corresponding PL7... module.

PL82 - Dim: mm 118x264x41 - **Hood cover for 2 modules** in aluminium. To be mounted together with the corresponding PL7... module.

PL83 - Dim: mm 118x376x41 - **Hood cover for 3 modules** in aluminium. To be mounted together with the corresponding PL7... module.

PL84 - Dim: mm 217x264x41 - **Hood cover for 4 modules** on 2 vertical rows in aluminium. To be mounted together with the corresponding PL7... module.



PL86 - Dim: mm 217x376x41 - **Hood cover for 6 modules** on 2 vertical rows in aluminium. To be mounted together with the corresponding PL7... module.



PL89 - Dim: mm 316x376x41 - **Hood cover for 9 modules** on 3 vertical rows in aluminium. To be mounted together with the corresponding PL7... module.



PL91 - Dim: mm 118x154x80 - **Rain shelter for 1 module.**

PL92 - Dim: mm 118x264x80 - **Rain shelter for 2 modules.**

PL93 - Dim: mm 118x376x80 - **Rain shelter for 3 modules.**

PL94 - Dim: mm 217x264x80 - **Rain shelter for 4 modules** on 2 vertical rows.

PL96 - Dim: mm 217x376x80 - **Rain shelter for 6 modules** on 2 vertical rows.

PL99 - Dim: mm 316x376x80 - **Rain shelter for 9 modules** on 3 vertical rows.

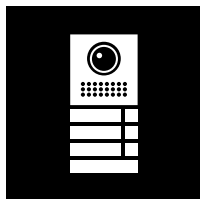

MATRIX

316L stainless steel
 guaranteed anti-vandal
 elegance
 modularity
 even for big number of users

Matrix withstands tampering, penetration of solids and water jets. These technical specifications are guaranteed by IP45 and IK09 against external solid bodies and shocks. Total reliability even thanks "snake eyes" security screws.

Completely made in AISI 316L stainless steel. Thanks to modularity it guarantees video or just intercom installations even for high number of users and even in horizontal configuration.

audio and video modules



VD2120CMAS

Dim: mm 115x115x14

Colour audio-video module without call buttons. Camera is +/-10% horizontal and vertical adjustable, with 3.6 fixed lens. To be installed together with CD..MAS module with buttons or with TD2100MAS digital keypad module.



AD2110MAS

Dim: mm 115x115x14

Audio module without call buttons. To be installed together with CD..MAS modules with buttons or with TD2100MAS module with digital keypad.



digital keypad

TD2100MAS

Dim: mm 115x115x14

Digital keypad with stainless steel front plate and 14 buttons. Equipped with 16-digit display on 2 lines. It allows the call by dialling the corresponding number and electric lock release by entering the private code. The electronic index is also integrated, which gives the possibility to scroll the names in alphabetical order and select the desired one. This integration allows to further reduce space compared to other compositions. To be joint to VD2120MAS or AD2110MAS. It can store up to 250 user names.





conventional door panels

To be used in composition with
VD2120CMAS or AD2110MAS.



CD2131MAS

Dim: mm 115x115x14

Encoder with **1 button** for conventional external station, it can code up to 128 users.



CD2132MAS

Dim: mm 115x115x14

Encoder with **2 buttons** for conventional external station, it can code up to 128 users.



CD2134MAS

Dim: mm 115x115x14

Encoder with **4 buttons** for conventional external station, it can code up to 128 users.



MAS24S

Dim: mm 115x115x14

Additional button module with **4 buttons** with button encoding integrated for conventional external station.



MAS20

Dim: mm 115x115x14

Blank module to be used to complete the assembly.



installation elements

MAS61 - Dim: mm 140x140x14 - **Front frame** matt titanium grey colour for **1 module**. Provided with "snake eyes" security screws type.

MAS62 - Dim: mm 140x257x14 - **Front frame** matt titanium grey colour for **2 modules**. Provided with "snake eyes" security screws type.

MAS63 - Dim: mm 140x374x14 - **Front frame** matt titanium grey colour for **3 modules**. Provided with "snake eyes" security screws type.



MA71 - Dim: mm 128x128x65 - **Back box** for **1 module**.

MA72 - Dim: mm 128x245x65 - **Back box** for **2 modules**.

MA73 - Dim: mm 128x362x65 - **Back box** for **3 modules**.



MA91 - Dim: mm 146x145x92 - **Rain shelter** for **1 module**. Made in stainless steel.

MA92 - Dim: mm 146x262x92 - **Rain shelter** for **2 modules**. Made in stainless steel.

MA93 - Dim: mm 146x379x92 - **Rain shelter** for **3 modules**. Made in stainless steel.

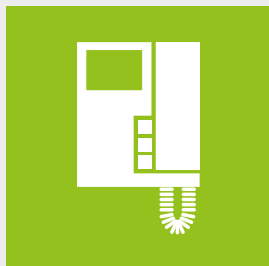

→ indoor stations

Duo System, in the offer for indoor stations, alongside the best ever ranges, such as **ZHero** and **Exhito**, there is **Sette**, the new-generation monitors with 7" screen and a captivating aesthetic of great class and character. All the solutions offer maximum performance for colour video door entry systems, with superior design and ergonomics.

Thanks to the many versions with different design and features, Farfisa guarantees an extensive assortment to satisfy the most stringent aesthetic and performance requirements. There are no limits with regard to customisation and attention to customer needs.

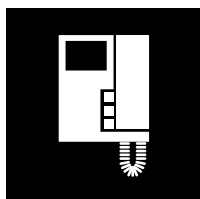

7" screen
essential design
hand-free

The Sette range consists of an only element, but capable of fulfilling the most stringent market requirements.

The sober and extremely rigorous design yields a profile that is surprisingly ultra-slim, an impression enhanced by the innovative sharp profile with 45° edges, which makes the product appear suspended from the wall.

It aptly embodies the gritty character of a company that strives to offer the ultimate solutions to its customers. The new monitor is named 'Sette' and **'Italian View'** is its payoff, because it shows the broadest possible view and guarantees the utmost security.

It mounts a **7" TFT LCD with 16:9 format**, for ultimate viewing of the scene captured by the video camera.

The product reveals an extensive and advanced level of development. LED-lit icons, soft-touch buttons and controls on the graphic interface allow for managing advanced video door entry system.

Sette is compatible with all Farfisa external door panels using the Duo System and can be integrated with different indoor stations. Moreover, it is suitable for IP and telephony applications.



SE4252

Dim: mm 194x156x25

Color hand-free videointercom with 7" LCD screen. Soft touch control for door opening and conversation, 4 buttons for intercommunication, auto-switch on and additional functions. Signalling LED'S for door open and bell exclusion. Possible further expansions through OSD menu.



TA4260

Dim: mm 150x149x125.

Table adaptor for Sette series monitors. Made in transparent / white methacrylate, it allows the practical usage of the videointercoms resting on a table. Provided with 2.4 m cable.

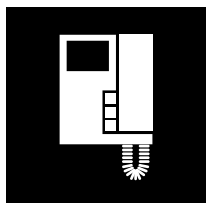

High level Design

*NEW***New version with 4.3" panoramic screen**

*hand-free
advanced audio system
elegance
backlit keys*

Hand-free colour videointercom, reduced dimension, simple and easy surface mounting (metal bracket included) without breaking the wall. Essential functions guaranteed

by ZHero are: conversation, door opening, bell exclusion, auto-switch on, intercommunication, actuators activation.

**ZH1262W***Dim: mm 123x168x29*

White colour monitor with **3,5" LCD display**. Soft touch buttons for activation of functions or to drive OSD system operations

**ZH1262B***Dim: mm 123x168x29*

Black colour monitor with **3,5" LCD display**. Soft touch buttons for activation of functions or to drive OSD system operations

**ZH1252WE (ZheroS)***Dim: mm 123x168x29.*

White colour videointercom, **4.3" screen**, programming through DIP switch.

installation elements

TA1260 - *Dim: mm 110x88x108* - **Table adaptor** for ZH1262W, ZH1262B, ZH1252WE.

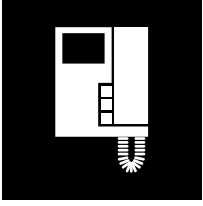

Exhito

*apparatus with handset
4" LCD screen
wide offer
the best quality/price ratio*

Videointercom with handset, white colour. Guaranteed functions by all Exhito monitors are: conversation activation, auto switch-on, door opening, intercommunication, actuators activation.

Exhito range includes only audio handsets. Too the guaranteed functions by all Exhito intercoms are: conversation activation, door opening, intercommunication, actuators activation.



EX3262C

Dim: mm 211x218x62

Colour monitor, 4" LCD screen. Provided with **7 function buttons** (of which 5 are programmable).



EX3252C

Dim: mm 211x218x62

Colour monitor, 4" LCD screen. Basic model, provided with **3 function buttons**.



EX362

Dim: mm 83x218x62

Intercom provided with **7 function buttons**, 5 of which are programmable.



EX352

Dim: mm 65x218x62

Intercom basic version, provided with **3 function buttons** of which 2 are programmable.

installation elements

WB3262 - **Wall bracket** for EX3262C.

WB3252 - **Wall bracket** for EX3252C.

TA3160 | TA320 - **Table adaptor** for Exhito monitors and intercoms respectively.



MC3000B | MC3000G | MC3000T - **Interchangeable plastic cover** blue, green and silver colour that replaces the one provided for the screen of Exhito monitor.

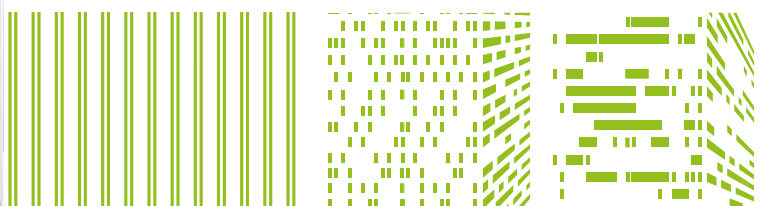



2 [↑] iP



gateway EVOLUTION

- **only one module** for whole the installation
- can be added to **already existing installations**
- extremely **simplified set-up** and **configuration**



→ **Proprietary cloud infrastructure**



→ **Bidirectional audio and remote door opening**



→ **Videocalls**



→ **Remote actuators management**

Gateway module that allows you to interface the Duo system to the IP world, expanding its functionality.

Among the features: the video call, conversing with the visitor and controlling access also remotely without limits of distances.

The system is based on the Farfsa cloud service developed specifically to make the installation, use and maintenance of the system as simple as possible. The gateway can be used not only for single-family installations, but also within one or more apartments of a multifamily system or **as a device shared** amongst all the apartments of the same system. In all cases the availability of an Internet connection, wired or wireless is required.

Each user can associate multiple mobile devices (Smartphone or Tablet) which will therefore activate simultaneously at the arrival of the call; only the user who will answer first, will be able to talk to the visitor and open the lock. The system integrates also the video memory function.

The IPWAY CLOUD application (that allows to end users to manage the installation remotely), is available for both **Android and iOS systems** in the respective stores.

By default, the GW2IP gateway module allows you to connect only one apartment, in order to add more, it is necessary to purchase the corresponding service separately. This service is sold individually, one for each apartment you need the call forwarding on a mobile device. In this way, you are able to get a solution perfectly tailored to your needs.



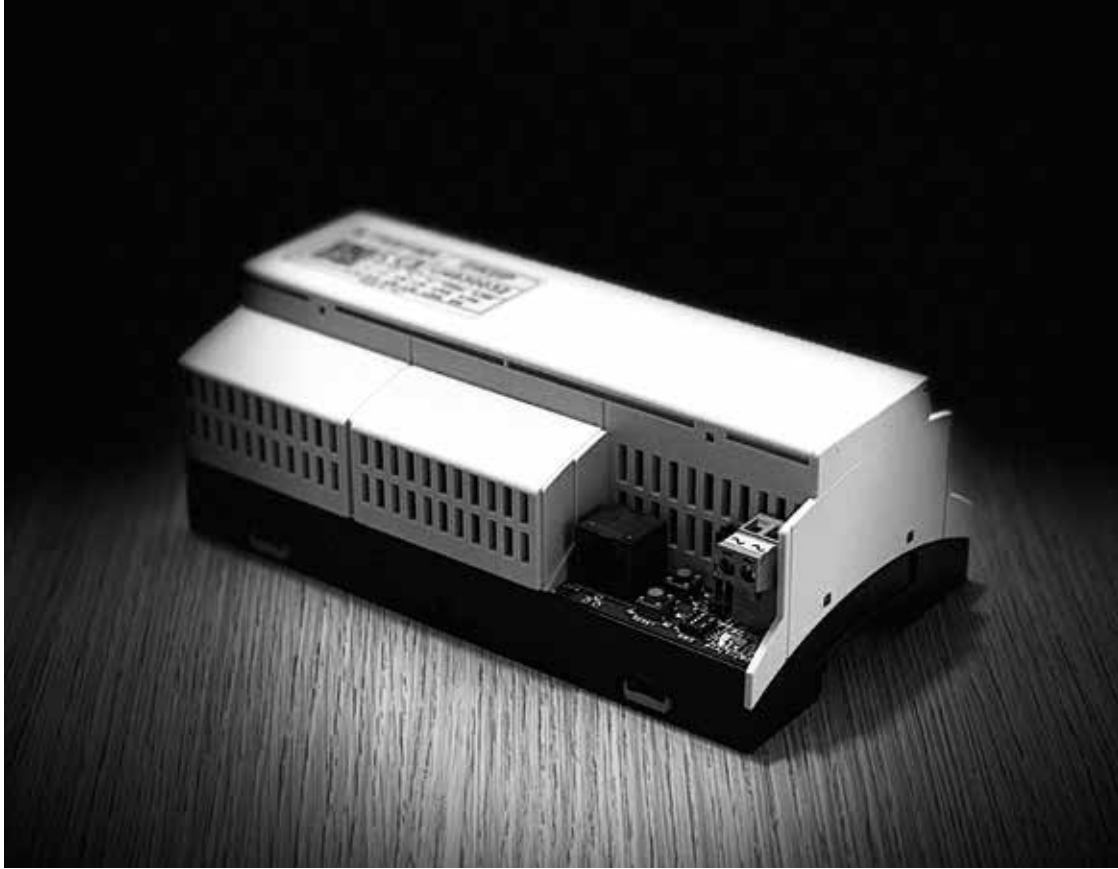

app



app



GW2IP

DIN rail **gateway** that **interfaces the DUO system to the IP world**. The gateway GW2IP can be powered either via the DUO bus or separately with a local power supply. Container installable on DIN bar (9 modules).

1US / GW2IP

Service to add a house-unit (Duo System user) **to the gateway**. Each gateway can manage up to a maximum of 50 houses-units. If an installation has more than 50 apartments, several gateway modules can be installed in parallel.

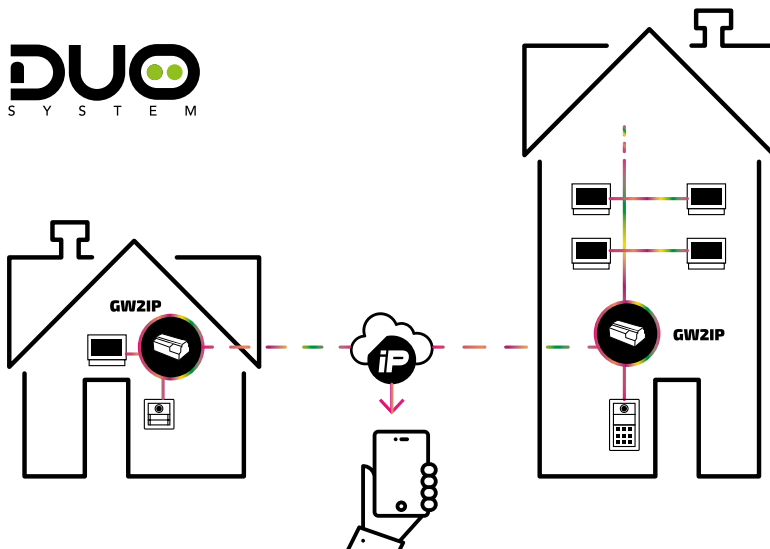

only one gateway module for each installation and all the installations manageable by a single connected device

→ door keeper exchanger



PDX2000

Dim: mm 209x186x67

Digital door - keeper exchanger, white colour. Available functions: internal station-internal station and external station-internal station communication, auto-insertion on external door station, day/night shunted switching, lost calls management. Further features: insertion on a busy user, opening of many doors even on non-specific demand, servant function, different colour for display lighting. Multiple door-keeper exchangers system allowed. Updating or data import through memory card. Call queuing and calls booking are available.



ST7100CW

Dim: mm 156x224x61

Colour monitor, 4" LCD screen, adjustable in inclination, auto switch-on button and an additional one. To be joint to PDX2000 door keeper exchanger

installation elements

TA7100W - White table adaptor, for ST7100CW monitors. Complete with cable clamp, junction box and 2.4 m connection cable with 20 wires. To be used with WB7260 wall bracket.

WB7260 - Wall bracket for ST7100CW monitors for connection to PDX2000 door - keeper exchanger

→ power supplies & accessories



2221MQ

Dim: 8 DIN A modules.

Linear power supply for Duo System bus. Power provided 38VA, output protected through PTC. Separate inputs for the line in 127 Vac and 230 Vac. It guarantees the appropriate audio and video impedance.



2221S

Dim: 6 DIN modules.

Switching power supply for Duo System bus. Power supplied 60VA, protected in output through PTC. It guarantees the proper audio-video impedance.



2220S

Dim: 3 DIN modules.

Power supply for door panels. Output 13 Vac/1 A protected against overloading and shortcircuits.



PRS210

Dim: 3 DIN modules in DIN bar.

15VA, 13 Vac transformer. VDE certification, can be used to power various products in Duo system.



2223Q

Dim: 3 DIN A modules.

Video signal amplifier. It allows to increase the max distance of Duo bus, it is possible to connect in cascade several amplifiers. It can be locally powered.



2231Q

Dim: 3 DIN A modules

Riser or block separator. It allows independent sections inside an installation, allowing to get local services without engaging the main building line.



2281Q

Dim: 1 DIN A module

Actuator for additional services, directly powered by the bus, it is provided with a power relay and input port for external sensors connection. Completely programmable and configurable depending on the installation requirements.



2302

Twisted pair **cable for internal**, each wire having single section of 1 sq.mm. 100 m reels available.



2302E

Twisted pair **cable for external**, each wire having single section 1 sq.mm. Specifically designed to be laid underground. 100 m reels available.



DM2421

Dim: mm 122 x 68 x 25

Riser distributor or video switcher that allows to selectively send the video signal, coming from door station, to videointercoms.

DM2444

Dim: 8 DIN module



Concentrator module that allows to selectively centralize up to 4 door panels and up to 4 risers. This configuration can be extended through connection in cascade of many devices.

VM2521

Dim: 3 DIN module



Video modulator, featuring 2 inputs for the connection of analogic PAL standard cameras. It can be used as independent device or, for an advanced video feed management, combined with suitable door panels.



DV2420

Dim: mm 43 x 36 x 25

Line **distributor** for the connection of power supplies or other accessories to Duo bus.



DV2421Q

Dim: mm 43 x 36 x 25

1 output signal distributor for Duo video or mixed audio-video risers.



DV2424Q

Dim: mm 122 x 68 x 25

4 Output distributor for videointercom Duo riser or audio-video ones.



2287

Dim: 8 DIN module

Selector for 4 or 7 exchanges. It allows the selection of max 4 or 7 surveillance cameras and/or other services activation. Output is to be sent to a modulator.



XT2928U

Interface board that allows the connection of any kind of analogue push button panel to Profilo / Agorà encoder modules of Farfisa digital systems. Each board can connect up to 16 buttons and it is possible to connect boards in chain.



PGR2991BT

Dim: 1 DIN A module

Programming module Bluetooth. It allows to programme all the devices in the installation through specific app "Duo System" available for Android and iOS smartphone.



XE2920

Bluetooth programming module for Alba door panels. It can be connected directly on the back of the push button panel and it allows to program all the devices of the system by the specific app "DUO SYSTEM" available for Android and iOS smartphones.



XE2921

Expansion board for Alba bus, it allows the integration of Bluetooth technology into the door station. It allows the timed access control functions and programming of all Duo system through Duo app.



XE2922

Expansion board for Alba and Hero bus, it allows the integration of Bluetooth technology into the door station. It allows access control simply by smartphone with app dedicated, available for free on App Store and Play Store. The lock opens via virtual keyboard and personal numeric code or with a simple touch the screen, in case the smartphone has been previously associated to the device.

app Farfisa Smart Access for Android→



app Farfisa Smart Access for iOS→



app Duo System for Android→



app Duo System for iOS→



KIT

→ **kits**

Many different kits come with the Duo technology and all the products offered are first-rate in terms of their flexibility, available solutions, design and affordability. Kits feature the Duo technology with external door panels self-powered from the bus; it is possible to choose either complete kits ready for installation or kits designed to contain the fundamental modules of a large installation.

Complete videokit

Ready and complete for the installation, include videointercom internal station, door panel and power supply.



SE4252ABW
One-way videokit with Alba CV2124AB door panel with 1 call button + SE4252 Sette monitor + 2221MQ power supply.



SE4252PDABW
One-way videokit with Alba CV2124AB door panel + PD2100AB access control keypad + SE4252 Sette monitor + 2221MQ power supply.



ZH1252ABW
One-way videokit with Alba CV2124AB door panel with 1 call button + ZH1252WE ZHeroS monitor + 2221MQ power supply.



ZH1252PDABW
One-way videokit with Alba CV2124AB door panel + PD2100AB access control keypad + ZH1252WE ZHeroS monitor + 2221MQ power supply.



ZH1252AGLEW
One-way videokit with VD2101AGL Agorà door panel with 1 call button + ZH1252WE ZHeroS monitor + 2221MQ power supply.

ZH1252AGLEW/2
Two-way videokit with VD2101AGL Agorà door panel with 2 call buttons + 2 ZH1252WE ZHeroS monitors + 2221MQ power supply.



EX3252AGLE
One-way videokit with VD2101AGL Agorà door panel with 1 call button + EX3252C monitor + WB3252 + 2221MQ power supply.

EX3252AGLE/2
Two-way videokit with VD2101AGL Agorà door panel with 2 call buttons + 2 Exhito EX3252C monitors + WB3252 + 2221MQ power supply.

Complete audio kits

Ready and complete for the installation, include intercom internal station, door panel and power supply.



1AEX352LE
One-way audio kit with AD2101AGL Agorà door panel with 1 call button + Exhito EX352 intercom + 2221MQ power supply.

2AEX352LE
Two-way audio kit with AD2101AGL Agorà door panel with 2 call buttons + 2 Exhito EX352 intercoms + 2221MQ power supply.

Basic installation videokit

It includes the basic starting elements for a video installation at any users.



KITBVAB
Basic installation videokit with Alba CV2124AB door panel + 2 AB21 + 1 AB20 + 2221MQ power supply.

Basic installation audiokit

It includes the basic starting elements for an audio installation at any users.



KITBAAB
Basic installation audio kit with Alba CA2124AB + 2 AB21 + 1 AB20 + 2221MQ power supply.

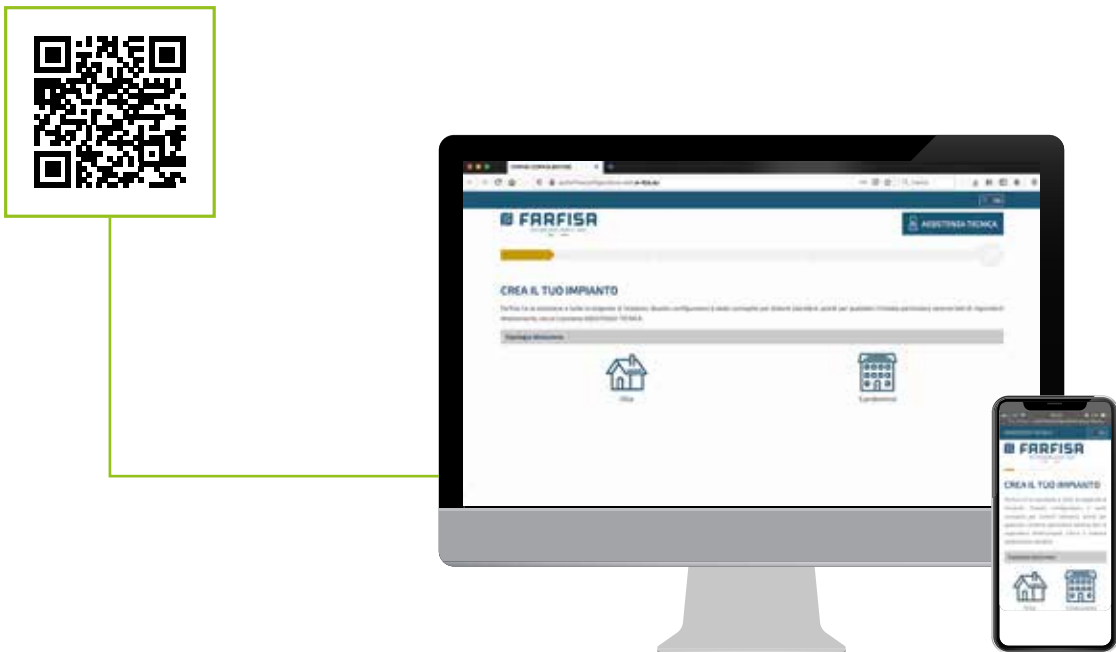

→ configurator

Discover the Farfisa configurator

Do you want to know the list of materials - in real time - necessary for your 2-wire Duo System? Farfisa allows you to create your own your list, customizable. It is a very interesting tool, indispensable for the professionals, which can also be used by the end user: **the Farfisa configurator**.







Directly from the www.farfisa.com/en website, log in freely and, guided in a fast and intuitive path, you will describe in a simple way the installation, based on its characteristics and aesthetic preferences. With the program you will get the material list of your system.

→ focus on Alba compositions

It's easy to create your Alba composition: choose if you need a composition with digital call (up to 20,000 users) or traditional push button call; if you prefer the traditional call





















follow the instructions on the following pages, consider that if you choose the 2 buttons in a row configuration, you will save space!

Table for Alba audio/video composition with digital call up to 20,000 users

1x A/V MODULE	1x DISPLAY	1x KEYPAD	2x SINGLE BUTTON	1x BACK BOX	1x RAIN SHELTER*	1x MODULE FRAME*	1x FRONT FRAME
							
CV2124AB/ CA2124AB	DD2140AB	PD2100AB	AB20	SC3	AB93	AB73	AB63





















*choose SC3 for flush mounting, or AB93 for surface mounting.

Composition Alba video or audio-video door panel on single row

NUMBER OF CALLS			1	2	3	4	5	6	7	8	9	10	11	12	13	14	15	16	17	18	19	20	21	22	23	24	25	26	27	28	29	30	31	32	33	34		
A/V MODULE		CV2124AB/CA2124AB	1	1	1	1	1	1	1	1	1	1	1	1	1	1	1	1	1	1	1	1	1	1	1	1	1	1	1	1	1	1	1	1	1	1	1	
BLANK M. / STREET NUMBER		AB00/AB50															1	1	1	1						2	2	2	2	1	1	1	1					
BUTTON		CT2138AB			1	1	1	1	2	2	2	2	3	3	3	3	4	4	4	4	5	5	5	5	6	6	6	6	7	7	7	7	8	8	8	8	8	
CALL BUTTON		AB21	1	2	3	4	5	6	7	8	9	10	11	12	13	14	15	16	17	18	19	20	21	22	23	24	25	26	27	28	29	30	31	32	33	34		
		AB20	1		3	2	1		3	2	1		3	2	1		3	2	1		3	2	1		3	2	1		3	2	1		3	2	1			
BACK BOX*		SC1	1	1																																		
		SC2			1	1	1	1					2	2	2	2																						
		SC3						1	1	1	1						2	2	2	2	2	2	2	2	3	3	3	3	3	3	3	3	3	3	3	3	3	
RAIN SHELTER*		AB91	1	1																																		
		AB92			1	1	1	1																														
		AB93						1	1	1	1																											
		AB94											1	1	1	1																						
		AB96																1	1	1	1	1	1	1	1													
MODULE FRAME		AB71	1	1																																		
		AB72			1	1	1	1					2	2	2	2																						
		AB73						1	1	1	1						2	2	2	2	2	2	2	2	3	3	3	3	3	3	3	3	3	3	3	3	3	3
FRONT FRAME		AB61	1	1																																		
		AB62			1	1	1	1					2	2	2	2																						
		AB63						1	1	1	1						2	2	2	2	2	2	2	2	3	3	3	3	3	3	3	3	3	3	3	3	3	3
CABLE		EC733										1	1	1	1	1	1	1	1	1	1	1	1	1	2	2	2	2	2	2	2	2	2	2	2	2		

*choose SC_ for flush mounting, AB9_ for surface mounting

Composition Alba video or audio-video door panel on double row

		NUMBER OF CALLS		2	4	6	8	10	12	14	16	18	20	22	24	26	28	30	32	34	36	38	40	42	44	46	48	50	52	54	56	58	60	62	64	66	68	
A/V MODULE		CV2124AB/CA2124AB	1	1	1	1	1	1	1	1	1	1	1	1	1	1	1	1	1	1	1	1	1	1	1	1	1	1	1	1	1	1	1	1	1	1	1	1
BLANK M. / STREET NUMBER		AB00/AB50																1	1	1	1					2	2	2	2	1	1	1	1					
BUTTON		CT2138AB			1	1	1	1	2	2	2	2	3	3	3	3	4	4	4	4	5	5	5	5	6	6	6	6	7	7	7	7	8	8	8	8	8	
CALL BUTTON		AB21	1	2	3	4	5	6	7	8	9	10	11	12	13	14	15	16	17	18	19	20	21	22	23	24	25	26	27	28	29	30	31	32	33	34		
		AB20	1		3	2	1		3	2	1		3	2	1		3	2	1		3	2	1		3	2	1		3	2	1		3	2	1		3	2
BACK BOX*		SC1	1	1																																		
		SC2			1	1	1	1					2	2	2	2																						
		SC3						1	1	1	1						2	2	2	2	2	2	2	2	2	3	3	3	3	3	3	3	3	3	3	3	3	3
RAIN SHELTER*		AB91	1	1																																		
		AB92			1	1	1	1																														
		AB93						1	1	1	1																											
		AB94												1	1	1	1																					
		AB96																1	1	1	1	1	1	1	1	1												
MODULE FRAME		AB71	1	1																																		
		AB72			1	1	1	1					2	2	2	2																						
		AB73						1	1	1	1						2	2	2	2	2	2	2	2	2	3	3	3	3	3	3	3	3	3	3	3	3	3
FRONT FRAME		AB61	1	1																																		
		AB62			1	1	1	1					2	2	2	2																						
		AB63						1	1	1	1						2	2	2	2	2	2	2	2	2	3	3	3	3	3	3	3	3	3	3	3	3	3
CABLE		EC733											1	1	1	1	1	1	1	1	1	1	1	1	1	2	2	2	2	2	2	2	2	2	2	2		

***choose SC_ for flush mounting, AB9_ for surface mounting**



IP & Home Automation



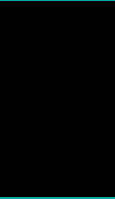

52 ***IP & Home
Automation***

plus

- **only one module** for whole the installation
- can be added to **already existing installations**
- extremely **simplified set-up** and **configuration**



your daily Solution

IP & Home Automation

In the Farfisa vision, the **IP and Home Automation** contexts, in which the system user requires continuous connection to his video door entry system, allowing **remote availability and reachability**, materialize with the extension of the Duo System digital system that interfaces with the IP world by means of the GW2IP Gateway module.

In other words the Duo System, through the new **GW2IP gateway** module and **proprietary cloud infrastructure**, makes it easy and accessible remote system management for both the installer and the end user.

In this simple way, Farfisa also addresses to the actual Home Automation needs: the **remote controls** are allowed, not only on the video door entry system, but also on the connected devices (for example external or internal lighting, appliances, boiler, alarm ...), using the basic and convenient elements of the Duo System.

DUO
S Y S T E M

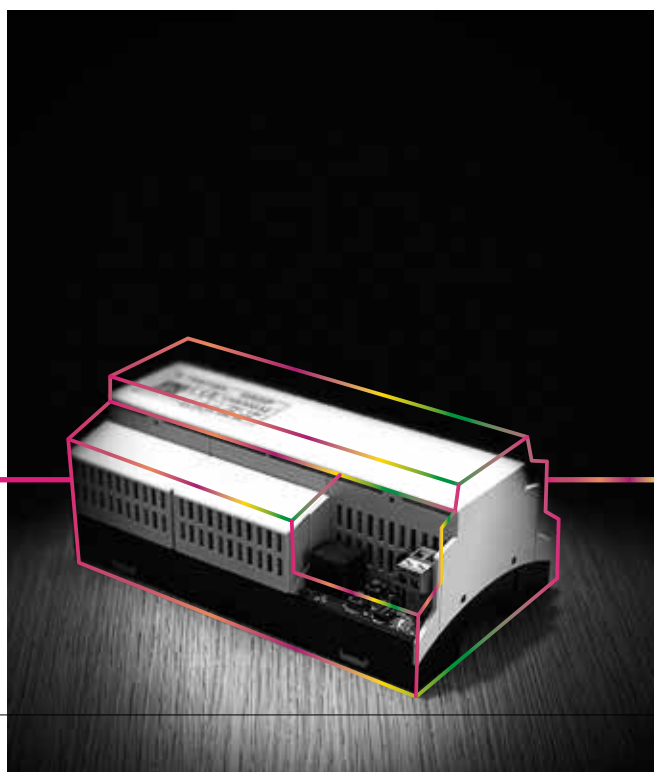
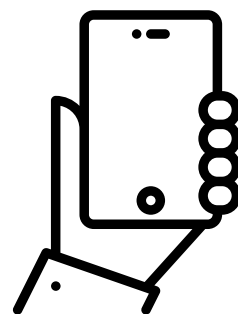
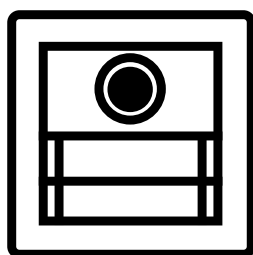



GW2IP

Gateway module that allows to interface the Duo system to the IP world, expanding its functionality.

Among the features: **the video call, conversing with the visitor and controlling access also remotely without limits of distances.**

The system is based on the Farfisa cloud service developed specifically to make the installation, use and maintenance of the system as simple as possible. The gateway can be used not only for single-family installations, but also within one or more apartments of a multifamily system or **as a device shared amongst all the apartments of the same system.**

In all cases the availability of an Internet connection, wired or wireless is required.

Each user can associate multiple mobile devices (Smartphone or Tablet) which will therefore activate simultaneously at the arrival of the call; only the user who will answer first, will be able to talk to the visitor and open the lock. The system integrates also the video memory function. The IPWAY CLOUD application is available for both Android and iOS systems in the respective stores.

The GW2IP gateway can be powered either via the DUO bus or separately with a local power supply. DIN rail container (9 modules).

The possibility to use the GW2IP in multi-user systems is linked to the purchase of the specific service

For further information, search for 1US/GW2IP on page 43.



app



app



Farfisa
IP cloud

For all the features of Duo System, go to page 26



2281Q

Dim: 1 modulo DIN A.

Actuator for additional services, directly powered by the bus, it is provided with a power relay and input port for external sensors connection. Completely programmable and configurable depending on the installation requirements.



VM2521

2-input video modulator for the connection of analogue cameras PAL standard ones. It can be used as independent device or, for an advanced management of video source, combined with suitable door stations.

An only gateway module for each installation

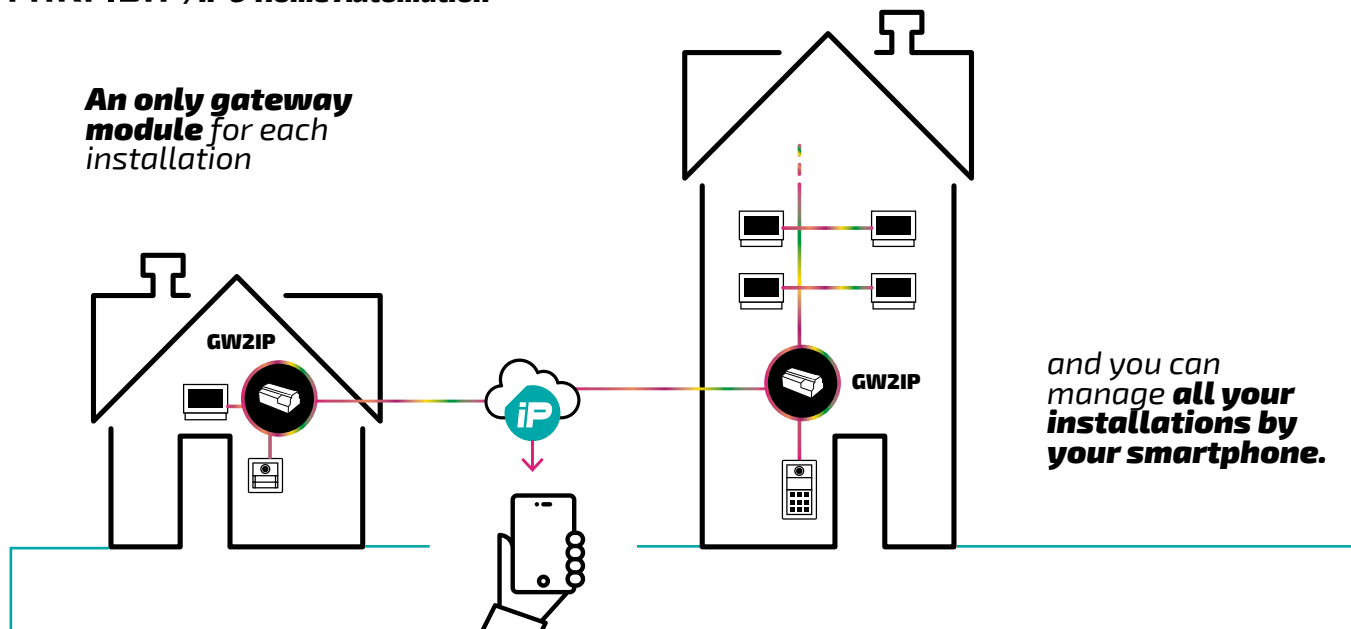

and you can manage **all your installations** by your smartphone.

functions

technical features



App IpWay Cloud for iOS and Android



Connecting to LAN via Ethernet or Wi-Fi



Proprietary cloud infrastructure



Automatic connection to cloud



Simplified web programming interface



Videocalls

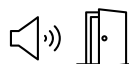

Bidirectional audio and remote door opening



Push notifications
Push notifications for lost call in case of missed answer



Control auto switch-on on all external stations in an installation



Audio activation with all the external stations even in case of auto switchon



Event list with all the calls, answers (even the lost ones), with time and date (for 1 month)



Video memory with 4 pictures for each received call (for 1 month)



Remote actuators management
Remote sensors management



Integration with videosurveillance cameras



Compatibility with existing Duo Systems



From your **smartphone** you can **activate and manage remotely** the devices connected to the **Duo installation.**

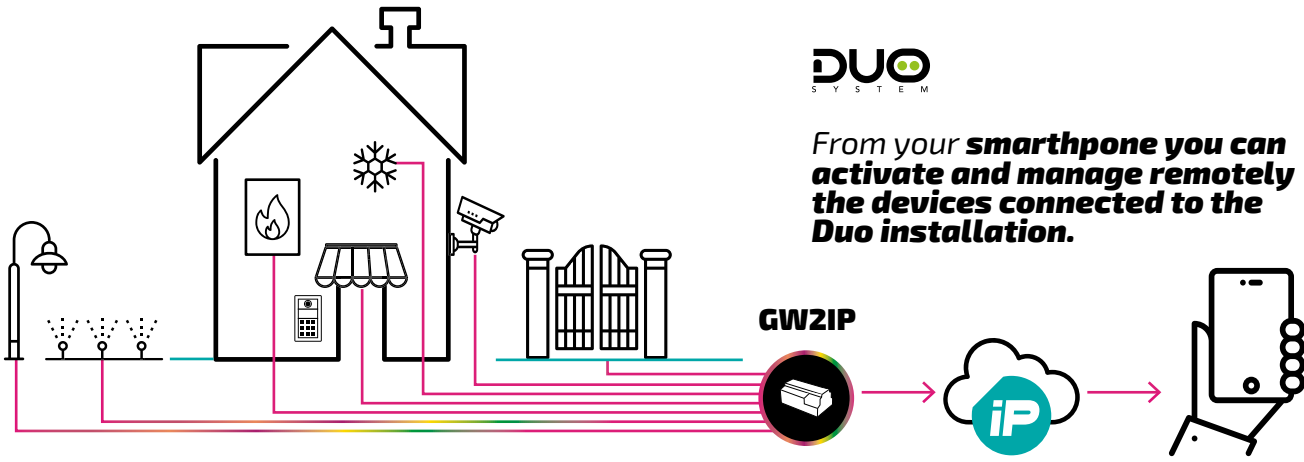

some application examples

You are in the office and somebody rings you at the door, but nobody is at home. **Your smartphone rings, you see the person ringing, you can talk to him and if you want, you can open the door and let him in.**



You are at the supermarket, your son rings at the door because he has not the keys, but nobody is at home. **Your smartphone rings, you see him, you talk to him, open the door and let him in.**

You are in your car and a visitor rings you at the door, but nobody is at home. **Your smartphone rings, you see the person, and if you want, you can talk to him and if you want you can open the door and let him in.**



You are having a bath and someone rings you at the door. **Your smartphone is near you and it rings, you see the person outside, you talk and if you want you can open the door.**

You are in a bar and you want to check if anyone is in the driveway. **Take your smartphone, go to the app and connect to the camera watching what is happening in front of the camera.**







59 videokit

The beauty now flexible with

PLUGGY

TECHNOLOGY



Pluggy is the **fastest and most convenient** way to have an excellent video door entry system guaranteed and **signed by Farfisa**.



Discover the ideal solution for 1-way systems: the Pluggy videokit is complete and ready for the installation, composed of high-level dedicated elements for the top in **design, technology, usability** and **installation**, including a valid solution for the expandability.



Pluggy technology offers to you a videokit consisting of 7" monitor in **Sette** line, door panel in **Alba** line and power supply unit, expandable up to 4 users! The monitor is also available separately to extend your system up to 4 indoor stations or to transform your 1-way system to make it up to 4-way.

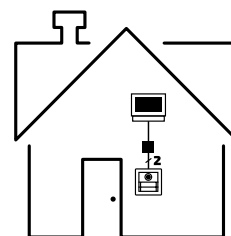

one way

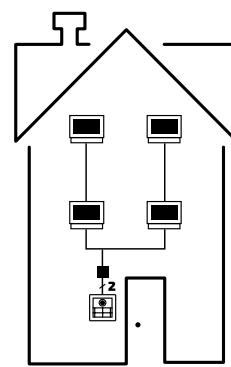

multi way



internal stations



SE77E



videokit



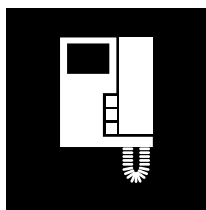
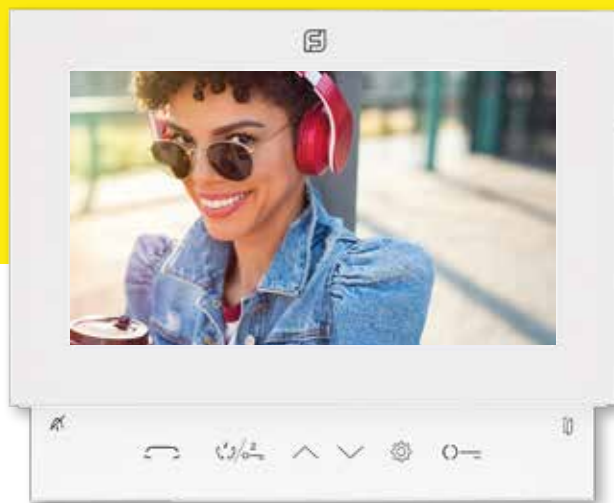

*design
technology
usability and installation*



SE7PG

Dim: mm 194x156x25

2 wires Pluggy videointercom, colour, hand-free in Sette line with LCD 7" screen, OSD menu interface, soft touch buttons and LED's icons for door opening, conversation, intercommunication and additional functions. Signalling LED's for open door and bell exclusion.



→ ***videokit***



KIT 1SEPG

Colour 1-way videokit composed by: SE7PG 7" monitor, hand-free, in Sette line + video door panel in Alba line with wide-angle camera, ready up to 4 call buttons + power supply, 2 wires digital Pluggy technology. The kit can be expanded up to 4 users by integrating the offer with the single SE7PG monitors.



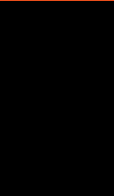

Mycom & Telephony

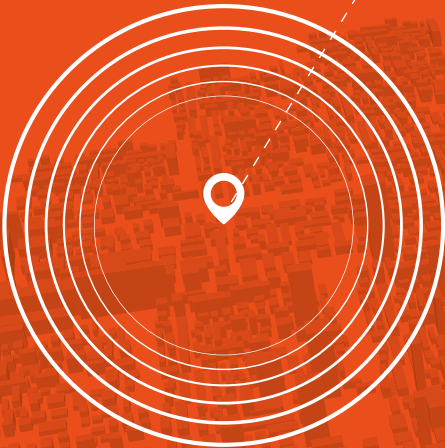



63 door panels

63 *Alba*



64 kits

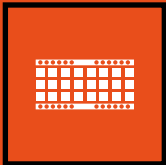

64 PABX



65 intercom-telephone interfaces



MYCOM & Telephony

TALKING EVERYWHERE

Telecommunication applications in residential estate are organized by Farfisa by several solutions. First of all myCom, with new and even more performant features with solutions on Alba door panels, where the call happens thanks to 3G technology.

Within the telephone communications range solutions, telephone PABX's are available, with extra and further accessories. These complete the possible solution, even for Duo System installations.

Under the name **myCom** we group solutions with **3G technology on Alba** door panels. Only few elements and a power supply unit are enough to have a complete and reliable communication system without door panel wiring.

The call originates from the door panel with conventional button modules or digital keypad and is forwarded to fixed or mobile telephones, whose numbers have been previously programmed in the door panel itself. You can manage, with several SIM cards, many entrances separately, for example door and gate.

Farfisa solution is an installation even pretty large (without limits in distance between outside station and inside receiver) with **no wiring at all**.

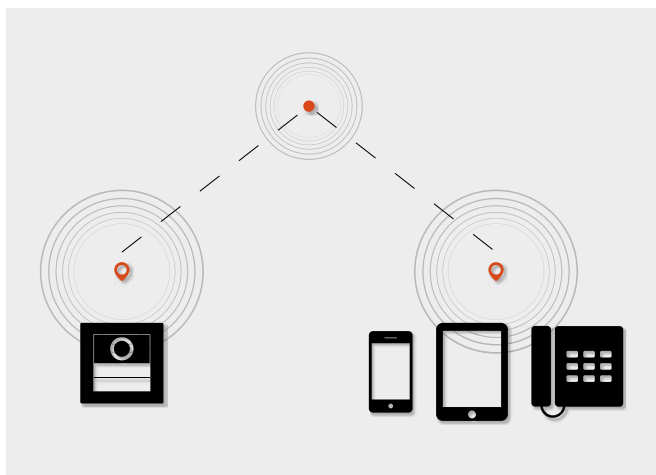

technical features

- 3G technology
- programming by web, USB, SMS or directly on SIM card
- low voltage power
- pre paid SIM card can be managed

functions

- can call to a land phone number or mobile phone number (3 numbers in cascade in case of no answer)
- CLIP function available. It allows caller identification for lock releasing
- 2 electric lock releases are permitted
- high number of users
- alarm activation managing

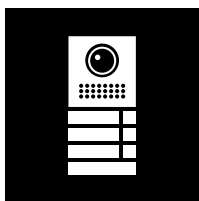

3G Alba call module



AB3G

Dim: mm99x91x9

Audio module with electric door speaker integrated and ready up to 4 calls (in double button way) for 3G My-Com systems.

Installation modules



PD2100AB

Dim: mm99x91x9

Digital keypad module, backlit. It allows the internal call through the coding of the corresponding number and door opening through reserved code. It can manage up to 200 users. It can be used combined with AB3G module in Mycom systems or see on page 29 with conventional functions in Duo System technology or see on page 70 as single module with access control function.

CT2138AB

Dim: mm99x91x9

Expansion button module ready up to 8 call buttons, combined with AB3G module in Mycom systems or page 29 with conventional functions in Duo System technology.



DD2140AB

Dim: mm 99x91x9

3.5" graphic LCD display module.

Electronic index is integrated that allows to scroll and select the single user. It can be combined with PD2100AB, CA2124AB, CV2124AB.



FP51AB

Dim: mm99x91x9

Proximity reader module

Alba range. Conceived as stand alone, even it can be installed in a composition of other modules and accessories of Alba series, even for surface or flush mounting. Provided with 1 relay, with programmable timer. Memory capacity 2000 cards, therefore it is ideal for the use in big estates or communities. Provided with 5 cards.

additional modules



AB20 - Dim: mm 90 x 22 - **Single button aluminium blank module**. To be mounted on AB3G or CT2138AB.



AB21 - Dim: mm 90 x 22 - **Button for single call**, programmable in order to be double call. To be mounted on AB3G or CT2138AB additional module. Braille is embossed to make it recognizable to visually impaired users. Backlit with white led.

To complete the composition of the door panel, if necessary, modules AB50 and AB00, respectively **street number module** and **blank module**, are available. For further details, please see page 30.

installation elements

Installation elements such as **front frames** (codes are AB61, AB62 and AB63), **module frames** (codes are AB71, AB72 and AB73), **rain shelters** (AB91, AB92, AB93, AB94, AB96) are available. **For further details see page 30.**

KIT

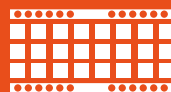

→ kits



1MCABS

MyCom kit 3G Alba surface mounting, it includes all necessary material for the installation of a door panel 3G up to 4 buttons. Articles inside are: AB3G door panel, AB91 rain shelter and PRS210 power supply together with AB61 and AB71 front and module frames and AB20 and AB21.



1MCAB

MyCom kit 3G Alba flush mounting, it includes all necessary material for the installation of a door panel 3G/up to 4 buttons. Articles inside are: AB3G door panel, SC1 box and PRS210 power supply together with AB61 and AB71 front and module frames and AB20 and AB21.



1MCPDAB

Kit with MyCom technology Alba 3G, mounting can be surface or flush, it is composed by: AB3G, access control keypad PD2100AB, Alba accessories AB72, SC2, AB92, AB20, 2xAB21, AB62 and power supply PRS210.

AN01

External antenna, complete with coaxial cable and proper connector in MyCom systems. It is useful in all the situations when the signal is weak. The bracket is not included.

AN02

Adaptor for external AN01 antenna for AB3G module.

→ PABX

The FT208E PABX represents the heart of Farfisa integrated communication, it enlarges the uses and capabilities of the telephone: the ideal answer to the ever-increasing communication needs of the home and the office.

The range includes PABX and additional boards. The PABX of the connected terminals: programming the telephones in different telephone features and intercom services (e.g. only certain local areas, only some telecommunication operators), setting distinctive ringing, associating a direct internal number with each telephone set (DISA function), defining a terminal as "fax", follow me, call capture, 3-party conference, automatic exchange to fax line, modem recognition, POS function and internal call control, LCR function.

Provided with intercom interface for 4+1 audio system. ID call function available for all the users. Up to 2 intercom calls management and 2 different entrances activation.

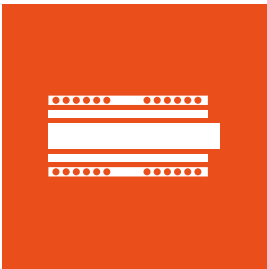

→ intercom telephone interfaces



FT208E
Telephone PABX with 2 trunk lines and 8 internal lines. The double intercom call, together with the possibility to divide the external lines on to 2 different bands of indoor stations, makes the FT208E the ideal solution for 2-way or home/office applications.

additional board

ES14E
Expansion board to add 1 trunk line/4 internal lines to get 3 trunk/12 internal in total.

	FT208E
<i>Power supply</i>	230V
<i>Maximum power consumption</i>	18W
<i>Power consumption in stand-by</i>	10W
<i>Temperature and humidity</i>	0° ÷ 40°C - 85% RH
<i>Dimensions</i>	215x120x70mm
<i>Weight</i>	1,05 kg
<i>No. of external lines</i>	2
<i>No. of internal lines</i>	8



FTDUO
Intercom telephone interface to interface the Duo System bus to any telephone PABX. This module allows audio only. Powered by Duo System bus. Programming through telephone keypad. 4 call buttons expandible up to 80.



FT11D
Intercom-telephone interface that allows a normal telephone to be connected to the telephone trunk line and the home intercom system. FT11D does not require any programming. Operation: during conversation, a background sound signal indicates the incoming of an intercom or telephone call to the user. The telephone conversation under way can be put on hold, with background music, in order to answer the intercom call. The intercom interface has a terminal board with the same numbering as a Farfisa intercom and can be part of a 4+1 intercom or alternate current call installation. Power supply 127-230V. Max power 7W. Dim: 8A DIN modules.



Access Control

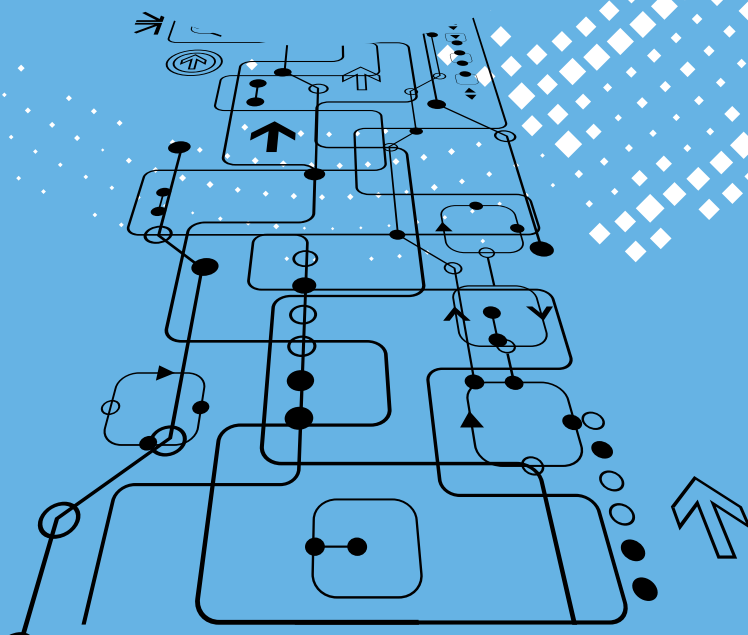



68 *proximity readers*



70 *keypads*



→ proximity readers

The selection of proximity readers is up-to-date and adapts harmoniously to the more versatile ranges of modular external stations in the catalogue: **Alba**, **Profilo** and **Mody**.

The system allows the opening of doors or gates to be activated so as to allow exclusive access to the card holder or the transponder once the element is simply approached to the reader. Among the range for access control, this choice is particularly suitable for communities or large residential complexes.



FP51AB

Dim: mm 99x91x9.

Stand alone proximity reader module that can be installed in composition with other modules and accessories of **Alba** series. For the installation -surface or flush mounting - accessories and elements of Alba range can be used, that allow to put this module inside a videointercom composition. Supplied with a relay with programmable timer. It can manage up to 2000 cards, therefore it is the ideal solution for access control for big estates or communities. Supplied with 5 cards.



FP52PL

Dim: mm 99x110x17

Aluminium **stand alone proximity reader** into a **Profilo** door panel module. Designed for access control, it exploits **Profilo** accessories for flush or surface mounting, so even compositions for videointercom system are possible. Supplied with two relays with programmable timer. The programming is made through a master card managed by a display and front LED's that indicate also data insertion of the enabled cards. Memory capacity is 500 cards, therefore ideal use is access control of complex buildings or communities. It is provided with 4 cards + 1 Master Card. Power supply 12 Vac/Vdc.



FP52

Dim: mm 124x90x18

Stand Alone Proximity Reader to be inserted in the **Mody** door panel composition, in anodised aluminium. Ideal for access control situations, it uses all the accessories of **Mody** push button panels for surface or flush mounting, it is possible to combine it in Videointercom installations. It is provided with two relays which timing is programmable. The programming is made through master card managed by a display and a LED on the front of the reader that indicates also the operation status and data insertion of the enabled cards. Memory capacity 500 cards. It is provided with 4 cards + 1 Master Card. Power supply 12 Vac/Vdc.



FP11/10

Set containing 10 cards in white plastic for proximity reader. ISO standard format.



FP12/10

Set composed by **10 transponder** units for activation of proximity readers. Together with the actual transponder, which is circular shaped joint to an useful metal key-holder with closing. Material is plastic in blue and white colour.



The Alba or Hero series devices can be integrated by the article XE2922, so as to obtain an alternative to proximity readers here indicated, guaranteeing the access control functionality (ref. page 29, 31).

Thanks to the new app FARFISA SMART ACCESS, from your smartphone the access function is allowed via Bluetooth technology.

Available on google play / apple store. The lock is opened via the virtual keypad and personal numeric code or with a simple touch of the screen, in case the smartphone is previously associated with the device.

new!



**App Farfisa
Smart Access
for Android** →



**App Farfisa
Smart Access
← for iOS**

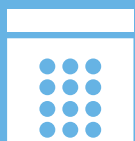

→ keypads

There is a wide range of devices for access control, with different models that respond to different needs, starting from the basic product up to keypads that, while always stand alone in function, guarantee greater security

once combined with a Video intercom system by using the modules with **Alba**, **Profilo**, **Matrix** or **Mody** lines.



PD2100AB

Dim: mm 99x91x9.

Digital keypad module, backlit. It allows the internal call through the coding of the corresponding number and door opening through reserved code. Thanks to **XE2922 integration via Bluetooth technology**, opening of the gate is allowed through the smartphone. Stand alone for access control or combined with DD2140AB display module, with CA2124AB audio module or CV2124AB audio-video module. If combined with CA2124AB or CV2124AB, it allows to activate remote actuators. If combined with XE2921, the system clock is used for timed functions. Programming manually or via Bluetooth. It can manage up to 1000 codes, equipped with 2 internal relays.



FC52PL

Dim: mm 99x110x17

Stand alone keypad with aluminium front plate and stainless steel buttons, that can be installed singularly or in composition with **Profilo** door panels for surface or flush mounting. Keypad for programming and setting relay enable codes of the two relays for door opening or access control etc. 12 programmable codes from 1 to 8 digits for each relay, programmable timer from 1 to 99 sec. or bistable working of relays. Power supply 12 Vac/Vdc.



FC52MAS

Dim: mm 115x115x14

Anti-vandal **stand alone keypad** (AISI 316L stainless steel) that can be installed singularly or combining it with conventional or digital audio or video **Matrix** composition. It works with 2 relays for lock opening, access control etc. with 12 programmable codes from 1 to 8 digits for each relay. Possibility to activate relays with additional buttons (exit button). Programmable timer from 1 to 99 seconds in monostable working, or bistable operation. Power Supply: 12 Vac/Vdc. Flush or surface mounting.

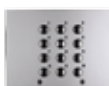

FC52P

Dim: mm 124x90x18

Access Control **keypad** with aluminium front plate and buttons in stainless steel **Mody** series. 2 relays for lock opening, access control, etc. Keypad for programming and setting relay enable codes. 4 programmable codes from 2 to 6 digits for each relay. Possibility to activate relay 2 with a single button. Programmable timer from 1 to 99 seconds or bistable operation of relay 1. Relay 1 can be activated by pressing an additional Exit button. Power supply 12 Vac/Vdc. Flush or surface mounting.



FC21E

Dim: mm 77x106x42

Access control **keypad** with front plate, buttons and box in plastic. One lockopening relay, access control, etc. Keypad for programming and setting relay enabling codes. 8 programmable codes from 2 to 6 digits. Programmable timer from 1 to 99 seconds or bistable operation. Power supply 12 Vac/Vdc. Surface mounting.

transformer



PRS210 - 15VA **transformer**. 13 Vac. VDE certification. 3 A modules on DIN bar. Ideal to power with alternate current Farcode Proximity Readers and Access Control Keypads elements.



FC32P

Dim: mm 85x110x54

Access Control **keypad** with stainless steel front plate and buttons. 2 relays for lock opening, access control, etc. Keypad for programming and setting relay enable codes. 4 programmable codes from 2 to 6 digits for each relay. Possibility to activate relay 2 with a single button. Programmable timer from 1 to 99 seconds or bistable operation of relay 1. Relay 1 can be activated by pressing an additional Exit button. Power supply 12 Vac/Vdc. Flush mounting.



FC42

Dim: mm 80x125x33

Access Control **keypad** surface mounted with stainless steel front plate and buttons. 2 relays for lock opening, access control, etc. Keypad for programming and setting relay enable codes. 12 programmable codes up to 8 digits for each relay. Programmable timer from 1 to 99 seconds or bistable operation of relay 1. Relays can be activated by pressing an additional Exit buttons. Power supply 12 Vac/Vdc.



1PEXFD

Complete **one way audio kit** that consists of Exhito EX321 intercom + door panel with modules PL11PED and FC52PL access control keypad with PL92 for surface mounting + PRS210ED power supply. Reduced wiring.



SE4252PDABW

One-way videokit with Alba CV2124AB door panel + PD2100AB access control keypad + SE4252 Sette monitor + 2221MQ power supply



ZH1252PDABW

One-way videokit with Alba CV2124AB door panel + PD2100AB access control keypad + ZH1252WE ZHero5 monitor + 2221MQ power supply



1MCPDAB

MyCom kit with Alba3G, surface or flush mounting, composed by: AB3G, PD2100AB access control keypad, accessories for Alba: AB72, SC2, AB92, AB20, 2XAB21, AB62 and PRS210 power supply.

Reduced Wiring, Electronic Call

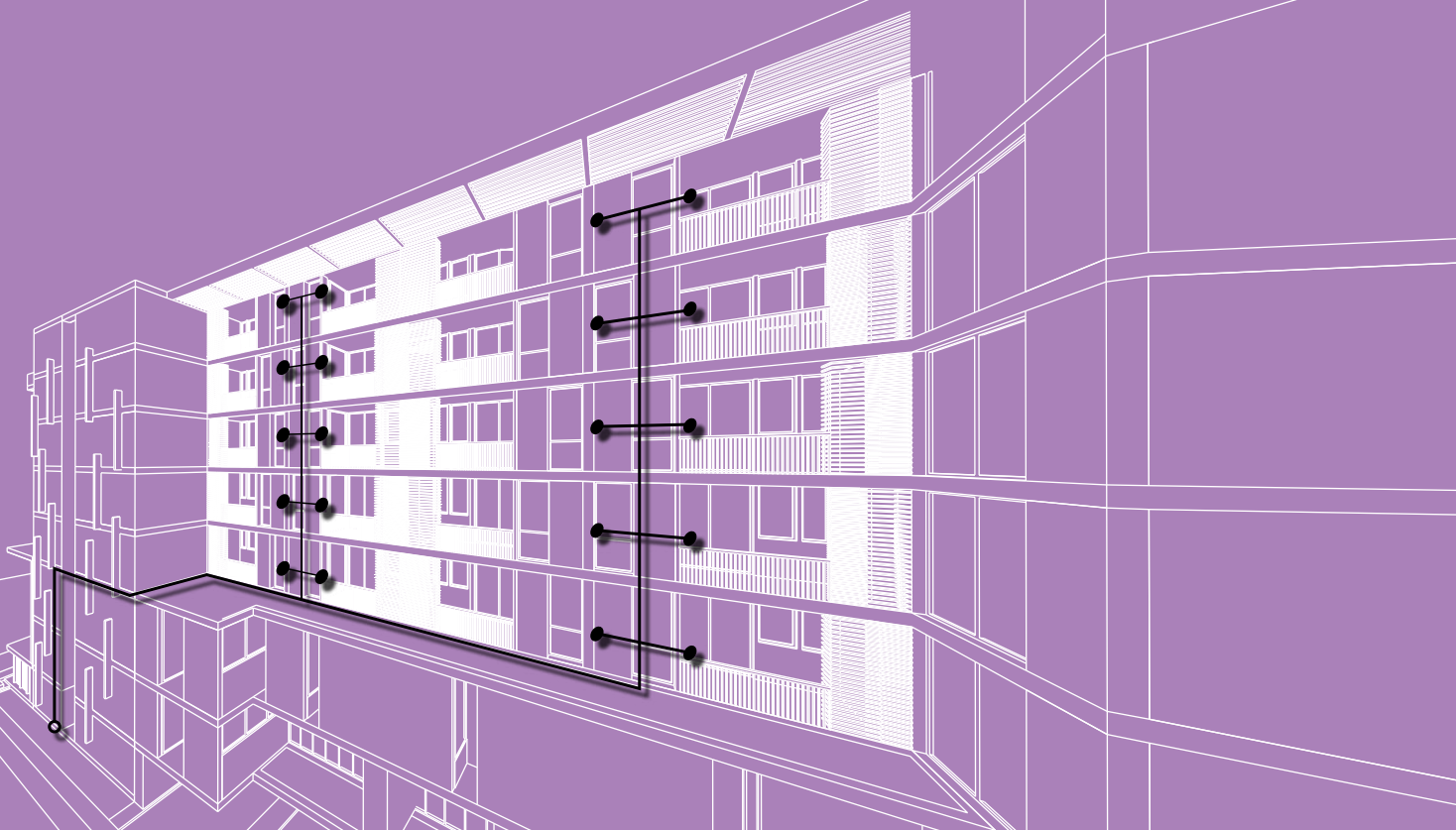



75 door panels

- 75** *Agorà*
- 76** *Profilo*
- 78** *Matrix*

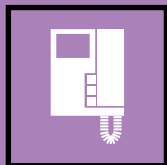

80 internal stations

- 80** *ZHero*
- 81** *Exhito*

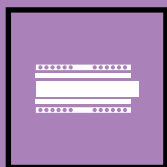

82 power supplies & service modules



83 kits

Reduced Wiring, Electronic Call

In the situations in which the analogue technology is a viable alternative to the digital, the reduced wiring solution is often the most suitable.

Reduced wiring means an electronic call Videointercom or intercom system with **reduced number of wires** referred to as 4+1 and 1+1, respectively, which can seamlessly integrate with each other.

The advantage is a notable simplification of the installation (comparing with conventional wiring), with the assurance of basic traditional functionality of the equipment and an improved quality/price ratio.

The reduced wiring systems have several aesthetics available for indoor stations like **ZHero** and **Exhito**, while for door panels you can choose between **Agorà**, **Profilo** and **Matrix**, a wide variety of aesthetic choices.



door panels



AGORÀ



Profilo



MATRIX



indoor stations



ZHERO



Exhito



power supplies & service modules



kits



→ door panels

The Farfisa 4+1 video or 1+1 audio reduced wiring system uses different aesthetic ranges for door panels: Agorà, Profilo, Matrix. Specifically, Agorà can be surface mounted, protruding very little from the wall because of the shallow depth of the base modu-

le. Amongst the other modular door panels, particularly Profilo, thanks to the optimized dimensions, is ideal even for compositions where space is limited in width. Matrix – elegant and refined – offers antivandal resistance guaranteed by IP45 and IK09.

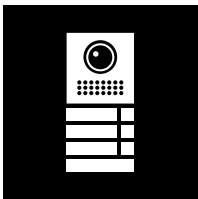

AGORÀ

modular concept
reduced dimensions
easy mounting



AGL100V

Dim: mm 99x208x30

Composed by surface mounting box, front plate with frame, cover for camera and door speaker, ready for **up to 2 call buttons**. Nearby photo with: composition of audio-video modules already assembled (separate elements mounted together).



AGL100A

Dim: mm 99x208x30

Composed by surface mounting box, front plate with frame, cover for door speaker and ready for **up to 4 call buttons**. Nearby photo with: composition of audio modules already assembled (separate elements mounted together).



AG30ED

Electric door speaker module for **only audio** door panels, reduced wiring technology. To be combined with AGL100A door panels.



note: Items are available also in dark grey colour.



AG40CED

Electric door speaker and camera module for audio-video door panels, reduced wiring technology. Color camera is adjustable +/-10° horizontal and vertical with fixed pin-hole 3.6 mm lens. To be combined with AGL100V door panels.



AGL100T

Dim: mm 99x208x30

Composed by surface mounting box and front plate with frame. Ready for installation of **8 single call button** modules, for combination with audio-video or only audio door station. Nearby photo with push buttons configuration at maximum extension. Modular concept reduced dimensions easiness of use.



accessories

AGL21 - **Single call button module.**

AGL20 - **Blank button module**

WA12AG - Dim: mm 146x254 - **Wall adaptor** including anodized aluminium rain shelter that allows the replacement of an existing built-in Mody door panel (**2 modules**) with a surface Agorà module. It is supplied with holes conceived to cover the previous mountings with MD71 or MD72.

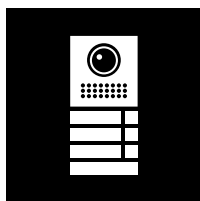

*modular soul
big versatility
even for big number of users*

Modular door panel, reduced dimensions, suitable also for limited space. Anodised extruded aluminium front plate and steel call buttons, with username labels backlit in green to facilitate identification and reading even under poor illumination.

Guarantees a high number of users even with its compact dimensions, thanks to the small size of the single module and the optimised use of space with the double call button.



PL40PCED

Dim: mm 99x110x17

Colour +/-10° adjustable in horizontal and vertical **camera module** with 3.6 mm fixed lens with integrated door speaker without call buttons for 4 + 1 reduced wiring systems.



PL41PCED

Dim: mm 99x110x17

Colour +/-10° adjustable in horizontal and vertical **camera module** with 3.6 mm fixed lens with integrated door speaker **with 1 call button** for 4 + 1 reduced wiring systems.



PL42PCED

Dim: mm 99x110x17

Colour +/-10° adjustable in horizontal and vertical **camera module** with 3.6 mm fixed lens with integrated door speaker **with 2 call buttons** for 4 + 1 reduced wiring systems.



PL10PED

Dim: mm 99x110x17

Audio module with integrated door speaker without call buttons for 1 + 1 reduced wiring systems.



PL11PED

Dim: mm 99x110x17

Audio module with integrated door speaker **with 1 call button** for 1 + 1 reduced wiring systems.



PL12PED

Dim: mm 99x110x17

Audio module with integrated door speaker **with 2 call buttons** for 1 + 1 reduced wiring systems.

additional modules

To reach desired number of buttons.



PL21

Dim: mm 99x110x17

Module with 1 additional call button to mount together with video PL4..ED or audio PL1..ED modules.



PL22

Dim: mm 99x110x17

Module with 2 additional call buttons to mount together with video PL4..ED or audio PL1..ED modules.



PL23

Dim: mm 99x110x17

Module with 3 additional call buttons to mount together with video PL4..ED or audio PL1..ED modules.



PL24

Dim: mm 99x110x17

Module with 4 additional call buttons to mount together with video PL4..ED or audio PL1..ED modules.



PL226

Dim: mm 99x110x17

Module with 6 additional call buttons on 2 rows to mount together with video PL4..ED or audio PL1..ED modules.



PL228

Dim: mm 99x110x17

Module with 8 additional call buttons on 2 rows to mount together with video PL4..ED or audio PL1..ED modules.

**PL50**

Dim: mm 99x110x17

Street number module.

**PL20**

Dim: mm 99x110x17

Blank module to be used to complete the assembly.

241DMA

4 - diode module to be inserted in button modules PL21, PL22, PL23, PL24, PL226 and PL228 for audio 1+1 and video 4+1 systems

installation elements



PL71 - Dim: mm 91x133x47 - **Back box** with frame for **1 module**.

PL72 - Dim: mm 91x244.5x47 - **Back box** with frame for **2 module**.

PL73 - Dim: mm 91x356x47 - **Back box** with frame for **3 modules**.

PL81 - Dim: mm 118x153x41 - **Hood cover** for **1 module** in aluminium. To be mounted together with the corresponding PL7... module.

PL82 - Dim: mm 118x264x41 - **Hood cover** for **2 modules** in aluminium. To be mounted together with the corresponding PL7... module.

PL83 - Dim: mm 118x376x41 - **Hood cover** for **3 modules** in aluminium. To be mounted together with the corresponding PL7... module.

PL84 - Dim: mm 217x264x41 - **Hood cover** for **4 modules** on 2 vertical rows in aluminium. To be mounted together with the corresponding PL7... module.

PL86 - Dim: mm 217x376x41 - **Hood cover** for **6 modules** on 2 vertical rows in aluminium. To be mounted together with the corresponding PL7... module.

PL89 - Dim: mm 316x376x41 - **Hood cover** for **9 modules** on 3 vertical rows in aluminium. To be mounted together with the corresponding PL7... module

PL91 - Dim: mm 118x154x80 - Surface mounting **rain shelter** with frame for **1 module**.

PL92 - Dim: mm 118x264x80 - Surface mounting **rain shelter** with frame for **2 modules**.

PL93 - Dim: mm 118x376x80 - Surface mounting **rain shelter** with frame for **3 modules**.

PL94 - Dim: mm 217x264x80 - Surface mounting **rain shelter** with frame for **4 modules** on 2 vertical rows.

PL96 - Dim: mm 217x376x80 - Surface mounting **rain shelter** with frame for **6 modules** on 2 vertical rows.

PL99 - Dim: mm 316x376x80 - Surface mounting **rain shelter** with frame for **9 modules** on 3 vertical rows.



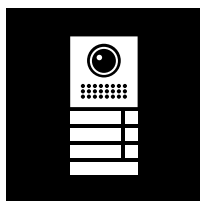

MATRIX

*316L stainless steel
guaranteed anti-vandal
elegance
modularity
even for big number of users*

Matrix withstands tampering, penetration of solids and water jets. These technical specifications are guaranteed by IP45 and IK09 against external solid bodies and shocks. Total reliability even thanks "snake eyes" security screws.

Completely made in AISI 316L stainless steel. Thanks to modularity it guarantees video or just intercom installations even for high number of users and even in horizontal configuration.



MAS43CED

Dim: mm 115x115

Colour +/-10° adjustable in horizontal and vertical **camera module** with 3.6 mm fixed lens with integrated door speaker with **1 call button** for 4+1 reduced wiring systems.



MAS11PED

Dim: mm 115x115

Audio module with integrated door speaker and **1 call button** for 1+1 intercom systems electronic call.

additional modules

To set the assembly.



MAS22

Dim: mm 115x115

Additional module with **2 call buttons** to join together with video MAS43CED or audio MAS11PED.



MAS20

Dim: mm 115x115

Blank module to complete the assembly.



MAS24

Dim: mm 115x115

Additional module with **4 call buttons** to join together with video MAS43CED or audio MAS11PED.

241DMA

4-diode module to be inserted in button modules MAS22, MAS24 for reduced wire technology.

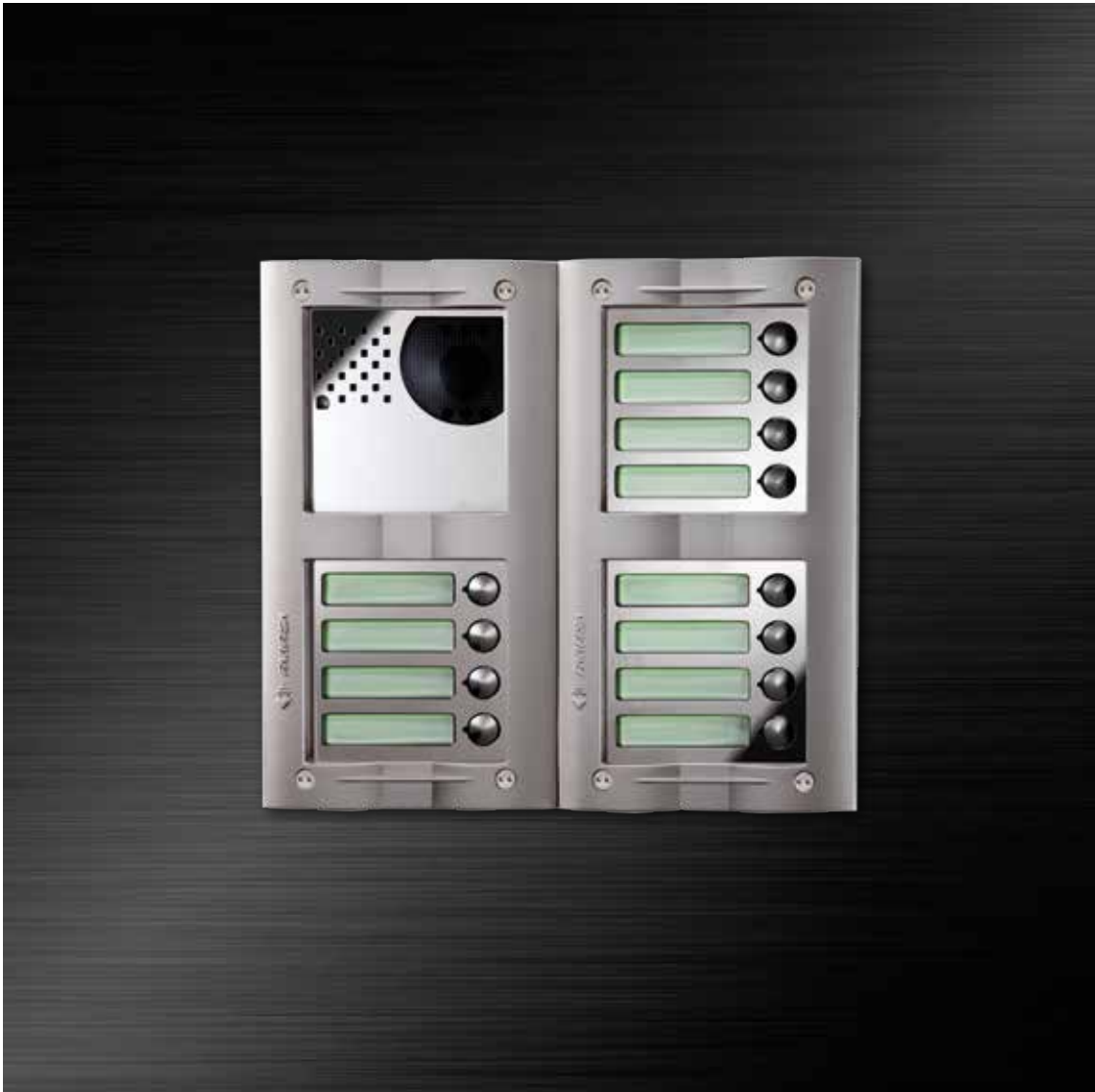

installation elements



MAS61 - Dim: mm 140x140x14 - **Front frame** matt titanium grey colour for **1 module**. Provided with security screws "snake eyes" type.

MAS62 - Dim: mm 140x257x14 - **Front frame** matt titanium grey colour for **2 modules**. Provided with security screws "snake eyes" type.

MAS63 - Dim: mm 140x374x14 - **Front frame** matt titanium grey colour for **3 modules**. Provided with security screws "snake eyes" type.

MA71 - Dim: mm 128x128x65 - **Back box** for **1 module**.



MA72 - Dim: mm 128x245x65 - **Back box** for **2 modules**.

MA73 - Dim: mm 128x362x65 - **Back box** for **3 modules**.

MA91 - Dim: mm 146x145x92 - Surface mounting **rain shelter** for **1 module**. Made in stainless steel.

MA92 - Dim: mm 146x262x92 - Surface mounting **rain shelter** for **2 modules**. Made in stainless steel.

MA93 - Dim: mm 146x379x92 - Surface mounting **rain shelter** for **3 modules**. Made in stainless steel.



→ *indoor stations*

The Farfisa reduced wiring video or audio system with electronic call offers different aesthetic ranges for indoor stations: ZHero

and Exhito, where ZHero – hand-free – has a modern design while Exhito is more flexible in the solutions, even allowing only audio installations.

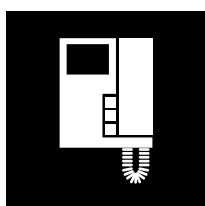

*hand-free
elegance
design*

Hand-free colour videointercom, reduced dimension, simple and easy surface mounting (metal bracket included) without breaking the wall. Essential functions guaranteed

by ZHero are: conversation activation, door opening, auto-switch on, additional activations.



ZH1151WE

Dim: mm 123x168x29

White color videointercom. 4.3" LCD screen. Conversation activation, door opening, bell exclusion, auto switch-on, further buttons for additional functions.

installation elements

TA1260 - Table adaptor for ZHero monitor made in painted metal.

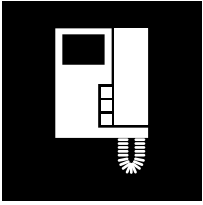

Exhito

apparatus with handset
wide offer
the best quality/price ratio



EX3160C

Dim: mm 211x218x62

Colour LCD 4" screen provided with **7 function buttons** (2 for auto switchon and door opening and further 5 for additional functions). It can be installed in reduced wiring systems if mounted with WB3161.



EX3100C

Dim: mm 211x218x62

Colour LCD 4" screen, basic version, provided with **3 function buttons** for auto switch-on, door-opening and additional functions to get the best quality/price ratio. It can be installed in reduced wiring systems if mounted with WB3161. EX3100CB monitor is available upon request, supplied with specific coil to ease the compatibility with hearing aid apparatus.



EX321

Dim: mm 83x218x62

Intercom for 1+1 reduced wiring, provided with **2 function buttons** of which 1 for door-opening. Extendable **up to 8 buttons in total**.



EX311

Dim: mm 65x218x62

Basic **intercom** for 1+1 reduced wiring audio systems, supplied with **2 buttons**, one of which for door-lock release and a further button for additional functions. Extendable up to 3 buttons in total.



installation elements

WB3161 - Wall bracket to mount on the wall EX3160C and EX3100C monitors in 4+1 reduced wiring.

TA3160 - Table adaptor for Exhito videointercoms. Made in metal, it is provided with 2.4 m cable with 20 conductors.

TA320 - Table adaptor for Exhito intercoms. Made in metal, it is provided with 2.4 m cable with 20 conductors.



accessories

MC3000B | MC3000G | MC3000T - Interchangeable plastic cover blue, green and silver colour that replaces the one provided for the screen of Exhito monitor.

EX301 - Additional push button for EX321 and EX311 intercoms.

EX304 - Supplementary loudspeaker to be inserted into EX321 intercom.



EX332 - 3 LED module to be inserted into EX321 to indicate auxiliary services





→ power supplies & service modules



1181E

Timed power supply - 127 - 230 Vac. 48VA outputs protected against overloading and short circuits. Output voltages: 13 Vac and 21 Vdc. VDE certification. 8 A modules in DIN bar.



1281

Stabilised power supply 127 - 230 Vac, 48VA, outputs protected against overloading and short circuits. Output voltages: 13 Vac and 21 Vdc. VDE certification. 8 A modules on DIN bar.



PRS210

15VA transformer. 13 Vac. VDE certification. 3 DIN modules.

1443ED

System module for intercommunication service in reduced wiring. 6 A modules in DIN bar.

DV2D

2-output **floor distributor.** Power supply: 12/21 Vdc. It can be fixed on the wall with expansion snogs or it can be inserted in derivation boxes.



DV4D

4-output **floor distributor.** Power supply: 12/21 Vdc. It can be fixed on the wall with expansion snogs or it can be inserted in derivation boxes.



1473

4 - **exchange switcher** for automatic switching of 2 door panels. 8 A modules in DIN bar.



1471

1 exchange relais module (5A-220Vac) and 2 command inputs: 13Vac, 21dc and electronic note. 3 A modules in DIN bar.

1471E

1 exchange relais module (5A-220Vac) and 2 command inputs: 13Vac, 21dc and electronic note. Provided with timed output for systems with electronic call and private conversation. 4 A modules in DIN bar.

1472

2-way exchanger (1A, 24V) 2 command input: 12 Vdc/Vac, 21 Vdc. Mountable in 3 A DIN module.

RL36

Relay module with one exchange (1A, 24V) to be integrated inside intercoms, it permits to drive 12 Vdc/Vac signal, electronic note and EC ground.

RL37D

It can drive the chime for intercoms and video intercoms, mountable on 4 A DIN module. 1 free supplementary contact is available, with electronic note. Power: 13 Vac.

PRS210ED

15VA transformer with electronic ringer. 13 Vac. 4 A modules in DIN bar or it can be mounted on the wall



KIT

→ kits

The one or two way solutions kits are very popular and they are easy to install because of the simple and intuitive wiring as the box

contains all the material needed for installation.

videokits

serie Exhito - Agorà



EX3111AGLC

Colour one - way video kit with Exhito internal station basic model and Agorà door station.

serie Exhito - Profilo



EX3111PLC

Colour one - way video kit with Exhito internal station basic model and Profilo door station.



EX3111PLC/2

Two way colour video kit with Exhito indoor stations basic model and Profilo door station.

audiokits



1AEXD

Audio one - way kit with Exhito internal station and Agorà door station.



1PEXD

Audio one - way kit with Exhito internal station and Profilo door station.



1PEXFD

One way audio kit with Exhito indoor station and Profilo external station equipped with access control keypad (for more details on FC52PL refer to page 68).



1CKD

Audio one - way kit with Exhito internal station and flush mounted door station Click series.



1CKSD

Audio one - way kit with Exhito internal station and surface mounted door station Click series.



2CKD

Audio two - way kit with Exhito indoor stations and flush mounted door station Click series.



2CKSD

Audio two - way kit with Exhito indoor stations and surface mounted door station Click series.

Conventional Wiring, Electronic Call

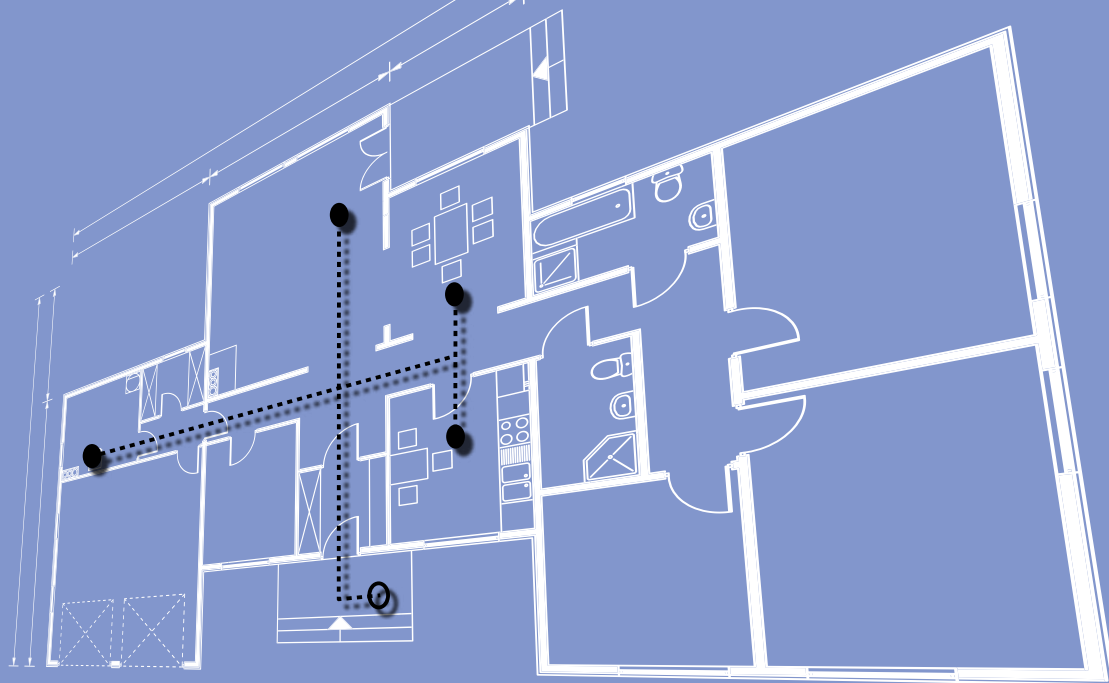



87 door panels

- 87** *Profilo*
- 89** *Mody*

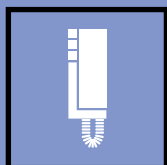

91 indoor stations

- 91** *Exhito*
- 92** *Project*
- 92** *700*

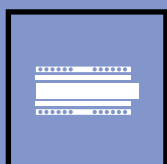

92 power supplies & service modules



93 kits

Conventional Wiring, Electronic Call

Some situations require the installation of an audio system using analogue technology with electronic call and traditional wiring, so we refer to systems with audio 4+1 wiring.

On these occasions Farfisa offers various aesthetic ranges to choose the most suitable for the the installation and aesthetic needs.

For indoor stations, classical or modern lines are available, while door panels have the choice between the all the different modular options: **Profilo** and **Mody**.



door panels



Profilo



MODY



indoor stations



700



PROJECT



Exhito



power supplies & service modules



kits

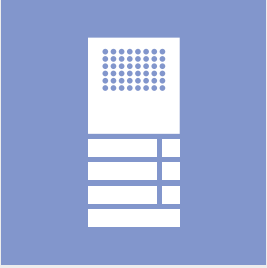

→ door panels

The door stations that can be used for conventional wiring systems with electronic call belong to the Profilo and Mody ranges, all of which are modular with maximum

space optimization. The use in an analogue technology accentuates the modular ability, emphasizing its versatility.

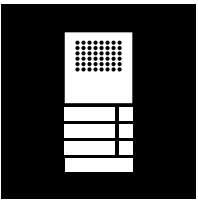

Profilo

*modular soul
big versatility
even for big number of users*



PL10P

Dim: mm 99x110x17

Audio module with integrated door speaker without call buttons for conventional wiring systems.



PL11P

Dim: mm 99x110x17

Audio module with integrated door speaker with **1 call button** for conventional wiring systems.



PL12P

Dim: mm 99x110x17

Audio module with integrated door speaker with **2 call buttons** for conventional wiring systems.



PL122P

Dim: mm 99x110x17

Audio module with integrated door speaker with **2 call buttons** on 2 rows for conventional wiring systems.



PL124P

Dim: mm 99x110x17

Audio module with integrated door speaker with **4 call buttons** on 2 rows for conventional wiring systems.



Additional modules

To set the assembly.



PL21

Dim: mm 99x110x17

Module with **1 additional call** button to combine with PL...P audio module.



PL22

Dim: mm 99x110x17

Module with **2 additional call** buttons to combine with PL...P audio module.



PL23

Dim: mm 99x110x17

Module with **3 additional call** buttons to combine with PL...P audio module.



PL24

Dim: mm 99x110x17

Module with **4 additional call** buttons to combine with PL...P audio module.



PL226

Dim: mm 99x110x17

Module with **6 additional call** buttons on 2 rows to combine with PL...P audio module.



PL228

Dim: mm 99x110x17

Module with **8 additional call** buttons on 2 rows to combine with PL...P audio module.



PL50

Dim: mm 99x110x17

Street number module.



PL20

Dim: mm 99x110x17

Blank module to be used to complete the assembly



Installation elements

PL71 - Dim: mm 91x133x47 - **Back box** with frame for **1 module**.

PL72 - Dim: mm 91x244.5x47 - **Back box** with frame for **2 modules**.

PL73 - Dim: mm 91x356x47 - **Back box** with frame for **3 modules**.

PL81 - Dim: mm 118x153x41 - **Hood cover** for **1 module** in aluminium. To be mounted together with the corresponding PL7... module.

PL82 - Dim: mm 118x264x41 - **Hood cover** for **2 modules** in aluminium. To be mounted together with the corresponding PL7... module.

PL83 - Dim: mm 118x376x41 - **Hood cover** for **3 modules** in aluminium. To be mounted together with the corresponding PL7... module.

PL84 - Dim: mm 217x264x41 - **Hood cover** for **4 modules** on 2 vertical rows in aluminium. To be mounted together with the corresponding PL7... module.

PL86 - Dim: mm 217x376x41 - **Hood cover** for **6 modules** on 2 vertical rows in aluminium. To be mounted together with the corresponding PL7... module.

PL89 - Dim: mm 316x376x41 - **Hood cover** for **9 modules** on 3 vertical rows in aluminium. To be mounted together with the corresponding PL7... module.

PL91 - Dim: mm 118x154x80 - Surface mounting **rain shelter** with frame for **1 module**.

PL92 - Dim: mm 118x264x80 - Surface mounting **rain shelter** with frame for **2 modules**.

PL93 - Dim: mm 118x376x80 - Surface mounting **rain shelter** with frame for **3 modules**.

PL94 - Dim: mm 217x264x80 - Surface mounting **rain shelter** with frame for **4 modules** on 2 vertical rows.

PL96 - Dim: mm 217x376x80 - Surface mounting **rain shelter** with frame for **6 modules** on 2 vertical rows.

PL99 - Dim: mm 316x376x80 - Surface mounting **rain shelter** with frame for **9 modules** on 3 vertical rows.



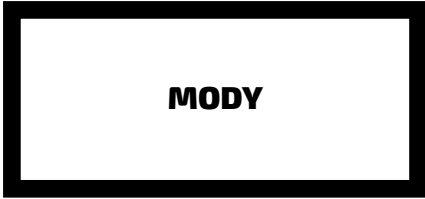
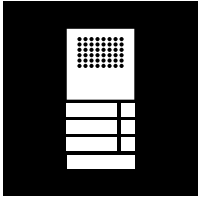

MD100

Dim: mm 124x90x18

Audio module with integrated door speaker for conventional wiring systems with **1 call button**.



MD200

Dim: mm 124x90x18

Audio module with integrated door speaker for conventional wiring systems with **2 call buttons**.



MD10

Dim: mm 124x90x18

Audio module ready for door speaker for conventional wiring systems without call buttons.



MD11

Dim: mm 124x90x18

Audio module ready for door speaker for conventional wiring systems with **1 call button**.



MD12

Dim: mm 124x90x18

Audio module ready for door speaker for conventional wiring systems with **2 call buttons**.



MD122

Dim: mm 124x90x18

Audio module ready for door speaker for conventional wiring systems with **2 call buttons** on 2 rows.



MD124

Dim: mm 124x90x18

Audio module ready for door speaker for conventional wiring systems with **4 call buttons** on 2 rows.



MD30

Speaker unit for 4+1 audio systems to be placed on the MD10, MD11, MD12, MD122, MD124.



additional modules

To set the assembly.



MD21

Dim: mm 124x90x18

Module with **1 additional** call button.



MD22

Dim: mm 124x90x18

Module with **2 additional** call buttons.



MD23

Dim: mm 124x90x18

Module with **3 additional** call buttons.



MD24

Dim: mm 124x90x18

Module with **4 additional** call buttons.



MD222

Dim: mm 124x90x18

Module with **2 additional** call buttons on 2 rows.



**MD224**

Dim: mm 124x90x18

Module with 4 additional call buttons.**MD226**

Dim: mm 124x90x18

Module with 6 additional call buttons on 2 rows.**MD228**

Dim: mm 124x90x18

Module with 8 additional call buttons on 2 rows.**MD20**

Dim: mm 124x90x18

Blank module to be used to complete the assembly.**MD50**

Dim: mm 124x90x18

Street number module.**installation elements****MD71** - Dim: mm 124x121.5x64 - **Back box** complete with module frame for **1 module**.**MD72** - Dim: mm 124x213x64 - **Back box** complete with module frame for **2 modules**.**MD73** - Dim: mm 124x304.5x64 - **Back box** complete with module frame for **3 modules**.**MD74** - Dim: mm 124x395x64 - **Back box** complete with module frame for **4 modules**.**MD81** - Dim: mm 151x140x40 - **Hood cover** for **1 module** in alluminium. To be joint to the corresponding MD7.. module.**MD82** - Dim: mm 151x231.5x40 - **Hood cover** for **2 modules** in alluminium. To be joint to the corresponding MD7.. module.**MD83** - Dim: mm 151x323x40 - **Hood cover** for **3 modules** in alluminium. To be joint to the corresponding MD7.. module.**MD804** - Dim: mm 151x414.5x40 - **Hood cover** for **4 modules** in alluminium. To be joint to the corresponding MD7.. module.**MD84** - Dim: mm 276x231.5x40 - **Hood cover** for **4 modules** on 2 rows in alluminium. To be joint to the corresponding MD7.. module.**MD86** - Dim: mm 276x323x40 - **Hood cover** for **6 modules** on 2 rows in alluminium. To be joint to the corresponding MD7.. module.**MD91** - Dim: mm 151x140x80 - Surface mounting **rain shelter** for **1 module**.**MD92** - Dim: mm 151x231.5x80 - Surface mounting **rain shelter** for **2 modules**.**MD93** - Dim: mm 151x323x80 - Surface mounting **rain shelter** for **3 modules**.**MD94** - Dim: mm 276x231.5x80 - Surface mounting **rain shelter** for **4 modules** on 2 rows.**MD96** - Dim: mm 276x323x80 - Surface mounting **rain shelter** for **6 modules** on 2 rows.

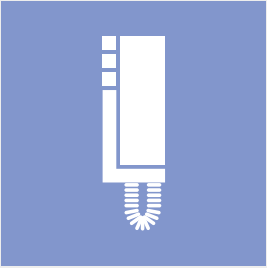

→ **indoor stations**

Exhito, Project and the historical **700** ranges of indoor stations are the solutions for conventional wiring that guarantee all the typical functions requested by the common installations.

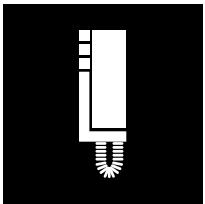

Exhito

wide offer
the best quality/price ratio



EX320R

Dim: mm 83x218x62

Intercom flexible version for conventional wiring, also with buzzer, provided with 2 function buttons of which 1 for door-opening extendible to 8 buttons.



EX310

Dim: mm 65x218x62

Intercom basic version for conventional wiring, supplied with 1 push button for door-opening extendible up to 3 buttons for the best quality/price ratio.

installation elements

TA320 - Table adaptor for Exhito intercoms. Made in metal, it is provided with 2.4 m cable with 20 conductors.

accessories

EX301 - Additional push button for Exhito intercoms.

EX304 - Supplementary loudspeaker to be inserted into EX320R intercoms.

EX332 - 3 LED module to be inserted into EX320R to indicate auxiliary services.





PROJECT



PT510W

Dim: mm 77x214x72

Basic intercom for conventional systems with electronic or alternate call, supplied with door opening button.

PT520GW

Dim: mm 86x214x72

Expandible intercom for conventional systems with electronic or alternate call supplied with 2 buttons expandible to 10 for door-opening, intercommunication calls and various services.

accessories

PT501G - Single button unit.

TA320 - Table adaptor compatible with Project series. Made in metal, it is supplied with 2.4 m cable with 20 conductors

SM50 - Private conversation module for systems with alternate current call. When installed inside the intercom, it allows only the called user to be put in communication with the external door station.



700



724N

Dim: mm 75x215x88

Intercom for alternate current call 4+1 systems. Complete with buzzer, door opener button and spiral cord.

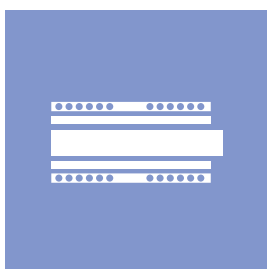

power supplies & service modules



PRS210

15VA transformer. 13 Vac. VDE certification. 3 DIN modules in DIN bar. It can be used any time alternate power is requested in low voltage.



PRS220

15VA power supply. 6 Vdc-13 Vac. VDE certification. 4 A modules in DIN bar.



PRS240

18VA power supply - commutator. 8 Vdc-13 Vac. VDE certification. 6 A modules in DIN bar. For intercommunicating intercoms connected to external door station.

PRS226E

18VA power supply - commutator. 8 Vdc-13 Vac. VDE certification. 6 A modules in DIN bar. For intercommunicating intercoms connected to external door station.

CV02

Inserted on the door panels, it acoustically warns that the call has been made.

1473

4 -exchange **exchanger** for automatic switching of 2 door panels. 8 A modules in DIN bar.



1471

2-command input **relay unit** (13 Vac; 12 Vdc, and electronic note). 3 A modules in DIN bar.

RL36

Relay module with one exchange (1A, 24V) to be integrated inside intercoms, it permits to drive 12 Vdc/Vac signal, electronic note and EC ground.

SR40

Electronic ringer module for systems with alternate current call. When installed inside the intercom, it allows the buzzer call to be replaced by the electronic call or a call to be added, e.g. a call from landing.

SR41

Electronic buzzer module.



→ **kits**

For one- or two-way intercom systems, audio kits are available. They are composed with Exhito indoor stations and the compact and elegant Click range door panel. Different versions are available for various number of users: surface or flush mounting, depending on the requirements



2CK

Two-way audio kit with Exhito indoor stations and flush mounted Click door panel.

2CKS

Two-way audio kit with Exhito indoor stations and surface mounted Click door panel.

1V/12V

Audio kit Victory series (one or multi-way up to 12) kit with Project indoor stations and ErreP/R door station.



1CK

One-way audio kit with Exhito internal station and flush mounted Click door panel.

1CKS

One-way audio kit with Exhito internal station and surface mounted Click door panel.



1MEXR

One-way audio kit with Exhito internal station and flush mounted Mody door panel.

2MEXR

Two-way audio kit with Exhito indoor stations and flush mounted Mody door panel.



0/9			
1AEX352LE	46	AB00	30
1AEXD	83	AB20	30, 63
1CK	93	AB21	30, 63
1CKD	83	AB3G	63
1CKS	93	AB50	30
1CKSD	83	AB61	30
1MEXR	93	AB62	30
1MCPDAB	71	AB63	30
1MCABS	64	AB71	30
1MCAB	64	AB72	30
1MCPDAB	64	AB73	30
1PEXD	83	AB81S	30
1PEXFD	71, 83	AB82S	30
1SEPG	59	AB83S	30
1US/GW2IP	43	AB91	30
1V	93	AB92	30
2AEX352LE	46	AB93	30
2CK	93	AB94	30
2CKD	83	AB96	30
2CKS	93	AD2101AGL	33
2CKSD	83	AD2110MAS	36
2MEXR	93	AD2120CPL	34
2PEXD	83	AD2121CAGL	33
2V	93	AG30ED	75
3V	93	AG40CED	75
4V	93	AGL20	33, 75
6V	93	AGL21	33, 75
8V	93	AGL100A	75
10V	93	AGL100T	75
12V	93	AGL100TS	33
241DMA	77, 78	AGL100V	75
290S/O	32	AN01	65
724N	92	AN02	65
1181E	82	C	
1281	82	CA2124AB	28
1443ED	82	CD2131MAS	37
1471	82, 93	CD2131PL	35
1471E	82	CD2132MAS	37
1472	82	CD2132PL	35
1473	82, 93	CD2134MAS	37
2220S	44	CD2134PL	35
2221MQ	44	CD2138PL	35
2221S	44	CT2138AB	28, 63
2223Q	44	CV02	92
2231Q	44	CV2124AB	28
2281Q	45, 53	D	
2287	45	DD2140AB	29, 63
2302	45	DM2421	45
2302E	45	DM2444	45
A		DV2D	82
		DV4D	82
		DV2420	45
		DV2421Q	45
		DV2424Q	45
		E	
		EC733	30
		ES14E	65
		EX301	81, 91
		EX304	81, 91
		EX310	91
		EX311	81
		EX320R	91
		EX321	81
		EX332	81, 91
		EX352	41
		EX362	41
		EX3100C	81
		EX3111AGLC	83
		EX3111PLC	83
		EX3111PLC/2	83
		EX3160C	81
		EX3252AGLE	46
		EX3252AGLE/2	46
		EX3252C	41
		EX3262C	41
		F	
		FC21E	71
		FC32P	71
		FC42	71
		FC52MAS	70
		FC52P	70
		FC52PL	70
		FP11/10	68
		FP12/10	68
		FP2000	32
		FP52	68
		FP51AB	30, 63, 68
		FP52PL	68
		FT11D	65
		FT208E	65
		FTDUO	65
		G	
		GW2IP	42, 53
		K	
		KITBAAB	46
		KITBVAB	46
		M	
		MA71	37, 79
		MA72	37, 79
		MA73	37, 79
		MA91	37, 79
		MA92	37, 79

MA93	37, 79	PL10P	87	SE4252	39
MAS11PED	78	PL10PED	76	SE4252ABW	46
MAS20	37, 78	PL11P	87	SE4252PDABW	46, 71
MAS22	78	PL11PED	76	SE7PG	59
MAS24	78	PL12P	87	SM50	92
MAS24S	37	PL12PED	76	SR40	93
MAS43CED	78	PL20	30, 77, 88	SR41	93
MAS61	37, 79	PL21	77, 88	ST7100CW	44
MAS62	37, 79	PL22	77, 88	T	
MAS63	37, 79	PL23	77, 88	TA320	41, 81, 91, 93
MC3000B	41, 81	PL24	77, 88	TA1260	40, 80
MC3000G	41, 81	PL24S	35	TA3160	41, 81
MC3000T	41, 81	PL40PCED	76	TA4260	39
MD10	89	PL41PCED	76	TA7100W	44
MD11	89	PL42PCED	76	TD2000	32
MD12	90	PL50	35, 77, 88	TD2000A	32
MD20	89	PL71	35, 77, 88	TD2000HE	31
MD21	89	PL72	35, 77, 88	TD2000R	32
MD22	89	PL73	35, 77, 88	TD2000RA	32
MD23	89	PL81	35, 77, 88	TD2100MAS	36
MD24	89	PL82	35, 77, 88	TD2100PL	34
MD30	89	PL83	35, 77, 88	TL2000	32
MD50	90	PL84	35, 77, 88	V	
MD71	90	PL86	35, 77, 88	VD2101AGL	33
MD72	90	PL89	35, 77, 88	VD2120CMAS	36
MD73	90	PL91	35, 77, 88	VD2120CPL	34
MD74	90	PL92	35, 77, 88	VD2121CAGL	33
MD81	90	PL93	35, 77, 88	VD2201AGL	29
MD82	90	PL94	35, 77, 88	VM2521	45, 53
MD83	90	PL96	35, 77, 88	W	
MD84	90	PL99	35, 77, 88	WA12AG	33, 75
MD86	90	PL122P	87	WB3161	81
MD91	90	PL124P	87	WB3252	41
MD92	90	PL226	76, 88	WB3262	41
MD93	90	PL228	76, 88	WB7260	44
MD94	90	PL228S	35	X	
MD96	90	PRS210	44, 71, 82, 92	XE2920	45
MD100	89	PRS210ED	82	XE2921	45
MD122	89	PRS220	92	XE2922	29, 31, 45
MD124	89	PRS226E	93	XT2928U	45
MD200	89	PRS240	92	Z	
MD222	89	PT501G	92	ZH1151WE	80
MD224	90	PT510W	92	ZH1252ABW	46
MD226	90	PT520GW	92	ZH1252AGLEW	46
MD228	90	R		ZH1252AGLEW/2	46
MD804	90	RL36	82, 93	ZH1252PDABW	46, 71
P		RL37D	82	ZH1252WE	40
PDX2000	44	S		ZH1262B	40
PD2100AB	29, 63, 70	SC1	30	ZH1262W	40
PGR2991BT	45	SC2	30		
		SC3	30		



Diagrams in this catalogue are a simple reference. For detailed installation schematics, please see the specific technical manual.

Due to the continuous technological evolution, Farfisa reserves the right to change the specifications of any item and range composition without prior notice.

As for CCTV sector, please refer to the specific Catalogue.

Cod: EN 02/20

→ design:

simonegrassi.eu

serena picchio

→ print:

TIPOGRAFIA LUCE di Osimo

→ photos:

Mom Studio

Maurizio Paradisi

Paolo Zitti

Giorgio Manzotti

Nicolò Cupido

Copyright © 2020:

ACI srl

Via E. Vanoni, 3

60027 Osimo AN

ITALY

Tel. (+39) 071.7202038

Fax (+39) 071.7202037

info@farfisa.com

www.farfisa.com



European mark for the conformity to EEC requirements.



Certified corporate quality system.



ACI srl

Via Ezio Vanoni, 3
60027 · Osimo (An)
ITALY

tel +39 071.7202038

fax +39 071.7202037

info@farfisa.com

www.farfisa.com

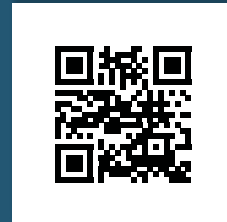

facebook

YouTube

LinkedIn

Instagram